

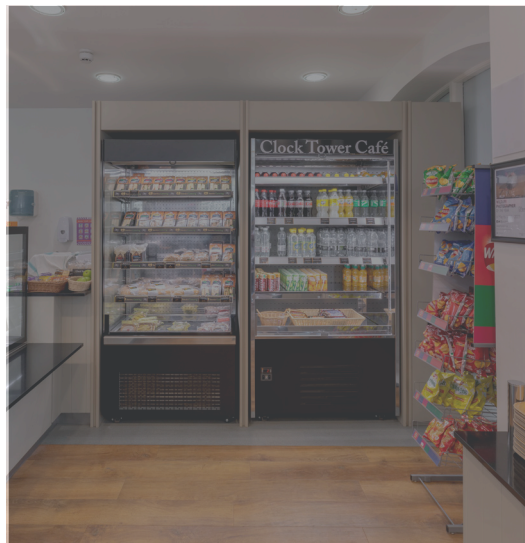

 **VICTOR**  
**Price List**



**2026/2027**



Hot Cupboards

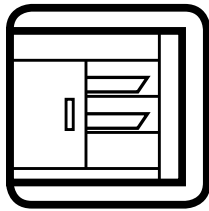

- HOT CUPBOARDS**
- 3 General Purpose
  - 5 Light Duty
  - 5 Plate Dispensers
  - 6 Ambassador Trolleys
  - 6 Gastronorm Containers
  - 7 Heated Drawers
  - 8 Heavy Duty
  - 9 Kitchen Servery Gantries

Banquette



- BANQUETLINE**
- 10 Heated models

Retail Displays

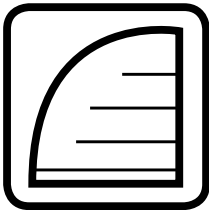

- RETAIL DISPLAYS**
- 12 Optimax
  - 13 Vista
  - 13 Evolution Plus
  - 14 Evolution
  - 15 Cake Display
  - 16 Maxiline Eco+
  - 16 Maxiline
  - 18 Deli Refrigerated Display

Toppers

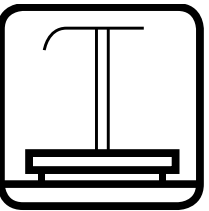

- TOPPERS**
- 19 Buffet Toppers
  - 19 Deli Toppers
  - 21 Heated Display Units
  - 21 Hot Food Merchandising / Pie Heaters
  - 22 Caribbean Toppers
  - 22 Burger Chutes

Caribbean

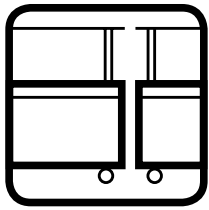

- CARIBBEAN**
- 23 Heated Modules
  - 24 Gantry Options
  - 25 Buffet / Carvery
  - 25 Refrigerated Modules
  - 27 Ancillary Modules

Jamaican

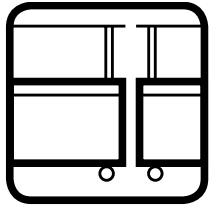

- JAMAICAN**
- 29 Heated Modules
  - 29 Refrigerated Modules
  - 30 Gantry Options
  - 32 Ancillary Modules

Synergy

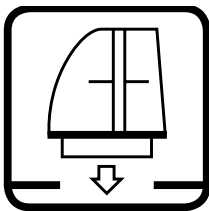

- SYNERGY**
- 33 Heated - Curved Glass
  - 35 Refrigerated - Curved Glass
  - 37 Heated - Flat Glass
  - 39 Refrigerated - Flat Glass
  - 40 Gantry-less units
  - 42 Complementary items

## WARRANTY POLICY

### WARRANTY PERIOD

All Victor catering equipment supplied to the United Kingdom mainland is guaranteed against defective workmanship, faulty components and materials for a period of 12 or 24 months from the point of installation.

### INSTALLATION

All Victor catering equipment must be installed by a suitable qualified contractor. Faults arising out of incorrect installation are not covered by this product warranty.

### AUTHORISED WARRANTY

Victor Manufacturing must authorise all warranty repairs prior to commencement of work. Work carried out on equipment without authorisation will not be covered under warranty nor will any resultant damage.

### SITE ACCESS

Warranty repairs are carried out between 8.00 a.m. and 5.00 p.m. on weekdays by prior arrangement. The customer must ensure that the engineer has access to the product at the time arranged.

### MAINTENANCE

Warranty does not cover routine maintenance or cleaning, however, users are advised that routine maintenance must be carried out in accordance with our instructions. This is of particular importance with refrigeration and gas fuelled appliances. Work made necessary by lack of routine maintenance or cleaning is not covered by this warranty and will be charged.

### IMPROPER USE

This warranty does not cover customer misuse or abuse resulting in broken components or damaged equipment. Some parts will not automatically be covered by this warranty (e.g. panels, glass, lamps, shelves, etc.). It should be noted that many surface finishes including paint, plastic coated steel, chrome and gold plating can be scratched and damaged if not properly cared for; such damage is not covered by this warranty.

The user must ensure that people using equipment are adequately trained.

### REFRIGERATION

It is important to note that warranty cover on refrigerated products is dependent upon the conditions in which the product is situated, which must fall within the temperature and relative humidity levels laid down in the product specification. It is the responsibility of the customer to ensure that working conditions are suitable.

Work carried out on equipment which does not fall within the scope of this warranty will be chargeable.

## Hot Cupboards - General Purpose

Stainless steel construction, all models operate from a single 13 amp supply and are supplied complete with two wire shelves & digital temperature display. Mobile units, fitted with 100mm swivel castors, 2 braked, length includes push bar.

Static units available on height adjustable legs at no additional cost, specify **Static** at time of order. These units are supplied without push bar, as such the length of the unit is reduced by 65mm.

### Plain Top - mobile

GN1/1 Gastronorm compatible hot cupboard



	945 x 670 x 900mm		1270 x 670 x 900mm		1600 x 670 x 900mm
Plain top					
<b>HC20MS</b>	<b>£1,875</b>	<b>HC30MS</b>	<b>£2,115</b>	<b>HC40MS</b>	<b>£3,045</b>
0.9kW		1.5kW		1.2kW	
With heated gantry					
<b>HC20MSG</b>	<b>£2,875</b>	<b>HC30MSG</b>	<b>£3,190</b>	<b>HC40MSG</b>	<b>£4,195</b>
1.5kW		2.4kW		2.4kW	
<i>Drop down tray slide</i>	<b>TS20</b>	add <b>£290</b>	<b>TS30</b>	add <b>£325</b>	<b>TS40</b> add <b>£385</b>
<i>Additional shelf &amp; supports</i>	<b>SHELF20</b>	<b>£55</b> each	<b>SHELF30</b>	<b>£55</b> each	<b>SHELF40</b> <b>£80</b> each

### Bains Marie - dry heat, mobile

GN1/1 Gastronorm compatible hot cupboard, Bains Marie accepts containers up to 150mm deep. Containers not included.



	945 x 670 x 900mm		1270 x 670 x 900mm		1600 x 670 x 900mm
Bains Marie top					
<b>BM20MS</b>	<b>£2,330</b>	<b>BM30MS</b>	<b>£2,695</b>	<b>BM40MS</b>	<b>£3,395</b>
1.9kW	2 x GN1/1	2.85kW	3 x GN1/1	2.4kW	4 x GN1/1
With heated gantry					
<b>BM20MSG</b>	<b>£3,345</b>	<b>BM30MSG</b>	<b>£3,770</b>	<b>BM40MSG</b>	<b>£4,550</b>
2.5kW	2 x GN1/1	3.0kW	3 x GN1/1	3.0kW	4 x GN1/1
<i>Drop down tray slide</i>	<b>TS20</b>	add <b>£290</b>	<b>TS30</b>	add <b>£325</b>	<b>TS40</b> add <b>£385</b>
<i>Additional shelf &amp; supports</i>	<b>SHELF20</b>	<b>£55</b> each	<b>SHELF30</b>	<b>£55</b> each	<b>SHELF40</b> <b>£80</b> each

### Plain Top - mobile

Not gastronorm compatible



	825 x 500 x 850mm		1205 x 450 x 900mm
Plain top			
<b>HC21MS</b>	<b>£1,835</b>	<b>HC31MS</b>	<b>£2,035</b>
1.5kW		1.5kW	
With 2 x GN 1/3 cut out in top			
<b>BM21MS</b>	<b>£1,895</b>		
1.5kW			
<i>Drop down tray slide</i>	<b>N/A</b>	<b>TSL30</b>	add <b>£325</b>
<i>Additional shelf &amp; supports</i>	<b>56-0215</b>	<b>£55</b> each	<b>56-0210</b> <b>£55</b> each

### Extras

<b>BMCV1</b>	Carvery insert/gravy dish for BM GN1/1 size .....	<b>£300</b>
<b>BMCV2</b>	Carvery insert full size for BM GN1/1 size.....	<b>£250</b>
<b>DHCP1</b>	Ceramic insert GN1/1 size.....	<b>£325</b>
<b>DHTP1</b>	Tiled insert GN1/1 size .....	<b>£355</b>
<b>CORN-B</b>	Four corner bumpers .....	<b>£150</b>
<b>P BAR</b>	Additional push bar .....	<b>£65</b>

### Gastronorm Container Packs

For BM20 models ( for BM40 models order 2 packs)		
<b>GNP21</b>	2 x GN1/1 & lids (150mm deep) .....	<b>£190</b>
<b>GNP22</b>	1 x GN1/1, 2 x GN1/2 & lids (150mm deep) .....	<b>£220</b>
<b>GNP23</b>	4 x GN1/2 & lids (150mm deep) .....	<b>£250</b>
For BM30 models		
<b>GNP31</b>	3 x GN1/1 inc. lids (150mm deep) .....	<b>£285</b>
<b>GNP32</b>	2 x GN1/1, 2 x GN1/2 & lids (150mm deep) .....	<b>£315</b>
<b>GNP33</b>	1 x GN1/1, 4 x GN1/2 & lids (150mm deep) .....	<b>£385</b>
<b>GNP34</b>	6 x GN1/2 inc. lids (150mm deep) .....	<b>£375</b>

For full product specification see Victor product brochure or visit [www.victoronline.co.uk](http://www.victoronline.co.uk)

email: [sales@victormfg.co.uk](mailto:sales@victormfg.co.uk)

tel: 01274 722125

**Hot Cupboards - General purpose - electric special models**

Stainless steel construction, all models operate from a single 13 amp supply and are supplied complete with two wire shelves & digital temperature display. Mobile units, fitted with 100mm swivel castors, 2 braked, length includes push bar.

Static units available on height adjustable legs at no additional cost, specify **Static** at time of order. These units are supplied without push bar, as such the length of the unit is reduced by 80mm.

**Bains Marie - wet or dry heat, mobile**

GN1/1 Gastronorm compatible hot cupboard, Bains Marie accepts containers up to 150mm deep not included.

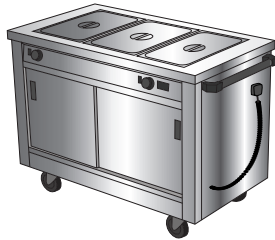

945 x 670 x 900mm		1270 x 670 x 900mm	
Bains Marie top			
<b>BM22MS</b>	<b>£2,735</b>	<b>BM32MS</b>	<b>£3,230</b>
2.0kW	2 x GN1/1	3.0kW	3 x GN1/1
With heated gantry			
<b>BM22MSG</b>	<b>£3,745</b>	<b>BM32MSG</b>	<b>£4,305</b>
2.6kW	2 x GN1/1	3.0kW	3 x GN1/1
Drop down tray slide <b>TSL20</b>		add <b>£290</b>	<b>TSL30</b> add <b>£325</b>
Additional shelf & supports <b>SHELF20</b>		<b>£55</b> each	<b>SHELF30</b> <b>£55</b> each

**Bains Marie - dry heat, mobile with serving flaps**

GN1/1 Gastronorm compatible hot cupboard, Bains Marie accepts containers up to 150mm deep not included.

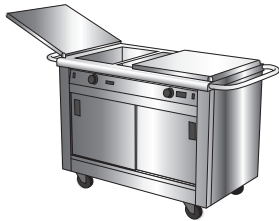

1310 x 710 x 900mm		1530 x 710 x 900mm	
Bains Marie top			
<b>BM20MSF</b>	<b>£3,350</b>	<b>BM30MSF</b>	<b>£3,715</b>
2.0kW	2 x GN1/1	3.0kW	3 x GN1/1
Additional shelf & supports <b>SHELF20</b>		<b>£55</b> each	<b>SHELF30</b> <b>£55</b> each

**Refrigerated blown air well - General purpose**

Stainless steel construction, all models operate from a single 13 amp supply and are supplied with digital temperature display and control. Mobile units, fitted with 100mm swivel castors, 2 braked. Designed to complement the standard range of general purpose hot cupboards.

Designed to meet the EN ISO 23953 standard providing M2 cabinet class conditions (1°C to 7°C core product temperature) in climate class 3 environment 25°C in 60% relative humidity.

**Refrigerated blown air well**

GN1/1 Gastronorm compatible well, 170mm deep accepts containers up to 100mm deep.

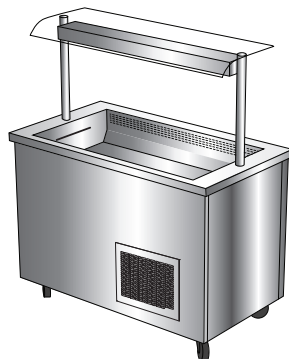

1205 x 670 x 900mm		1535 x 670 x 900mm	
<b>RW30MS</b>	<b>£6,365</b>	<b>RW40MS</b>	<b>£7,685</b>
1.6kW		2.4kW	
With LED gantry			
<b>RW30MSG</b>	<b>£7,395</b>	<b>RW40MSG</b>	<b>£8,865</b>
1.6kW		2.4kW	
Drop down tray slide <b>TS30</b>		add <b>£325</b>	<b>TS40</b> add <b>£385</b>

For full product specification see Victor product brochure or visit [www.victoronline.co.uk](http://www.victoronline.co.uk)

email: [sales@victormfg.co.uk](mailto:sales@victormfg.co.uk)

tel: 01274 722125

## Hot Cupboards - Light duty

A range of 7 lighter duty plate warmers / hot cupboards suited for the smaller catering operation. Stainless steel construction, variable thermostatic control with wire shelves.



**PRINCE** £1,115  
560 x 560 x 900mm 1kW  
3 removable shelves



**PRINCESS** £1,025  
560 x 360 x 900mm 1kW  
3 removable shelves



**REGAL** £995  
360 x 560 x 1200mm 1kW  
4 removable shelves

**JESTER** £875  
360 x 560 x 900mm 1kW  
4 removable shelves

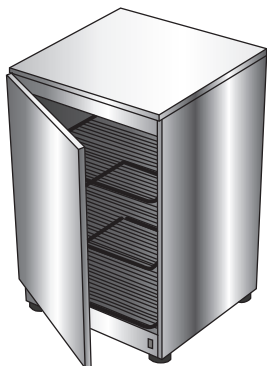

**DUKE** £875  
580 x 580 x 900mm 1kW  
3 adjustable shelves - preset thermostat

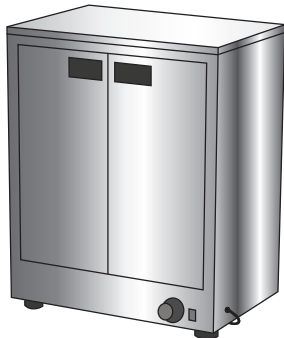

**TABLETOP** £895  
560 x 360 x 700mm 1kW  
3 removable shelves

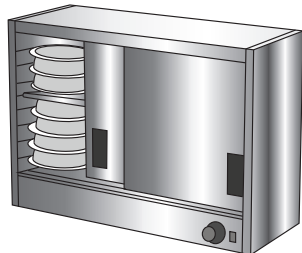

**EARL** £835  
900 x 330 x 625mm 1kW  
2 fixed shelves - wall mounted

## Plate dispensers - Mobile

Stainless steel construction, mobile units, fitted with 100mm swivel castors, 2 braked, adjustable spring loaded lowering mechanism, with removable crumb tray for cleaning. Heated units are fitted with a preset thermostat and supplied with a 13 amp plug and cable.

### Plate dispensers

Accepts plates 210mm - 285mm (8¼" - 11¼") approx 60 plates per tube.

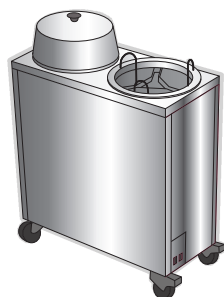

600 x 400 x 900mm		800 x 400 x 900mm	
unheated single		unheated double	
<b>PD1</b>	<b>£1,200</b>	<b>PD2</b>	<b>£2,015</b>
heated single		heated double	
<b>PDH1</b>	<b>£1,315</b>	<b>PDH2</b>	<b>£2,320</b>
0.8kW	with lid	0.8kW	with lids

### Extras

- 70-0210** Aluminium lid ..... **£95**
- CORN-B** Four corner bumpers ..... **£150**
- PUSH** Push bar ..... **£65**

Larger plate sizes to special order.

For full product specification see Victor product brochure or visit [www.victoronline.co.uk](http://www.victoronline.co.uk)

email: [sales@victormfg.co.uk](mailto:sales@victormfg.co.uk)

tel: 01274 722125

## Ambassador service trolleys

Combines dry heat Bains Marie top with either one heated & one chilled section (HotKold models) or two heated sections (HotHot models) complete with digital temperature display to hot cupboard.

### Ambassador - Standard models

C/w 100mm dia. castors, single push bar and 2 corner bumpers.



980 x 700 x 900mm		1270 x 700 x 900mm		1115 x 550 x 900mm	
HotKold St. St. finish					
<b>AMB2</b>	<b>£3,685</b>	<b>AMB1</b>	<b>£4,005</b>	<b>AMB5</b>	<b>£3,430</b>
1.75kW	2 x GN1/1	2.25kW	3 x GN1/1	1.75kW	1xGN1/1 & 1xGN1/3
HotKold Oak effect finish					
<b>AMB4T</b>	<b>£3,685</b>	<b>AMB3T</b>	<b>£4,005</b>	<b>AMB6T</b>	<b>£3,430</b>
1.75kW	2 x GN1/1	2.25kW	3 x GN1/1	1.75kW	1xGN1/1 & 1xGN1/3
HotHot St.St. finish					
<b>AMB42</b>	<b>£4,005</b>				
1.0kW	2 x GN1/1				

### Ambassador - Heavy duty models

C/w 150mm dia castors hinged top cover and two push bars.



1125 x 680 x 1000mm		1250 x 680 x 1000mm	
HotKold			
<b>AMB32</b>	<b>£5,585</b>	<b>AMB22</b>	<b>£5,995</b>
1.0kW	2 x GN1/1	1.0kW	3 x GN1/1
HotHot			
<b>AMB30</b>	<b>£5,405</b>	<b>AMB20</b>	<b>£5,890</b>
1.0kW	2 x GN1/1	1.0kW	3 x GN1/1

Fold over hinged top forms total serving area of: 1540 x 650mm 2400 x 650mm

### Options/extras

<b>AMBREC</b>	Recessed heated top .....	<b>£430</b>
<b>70-0110</b>	StayKold eutectic plates .....	<b>£70</b>
<b>PUSH</b>	Additional push bar .....	<b>£65</b>

### Cold sections use StayKold Eutectic plates.

AMB2/4/32 require 3 plates.  
AMB1/3/22 require 4 plates.  
(not included in the price)

## Gastronorm containers

All Gastronorm Containers are available from stock

Gastronorm size and dimensions (mm)									
	GN2/1	GN1/1	GN2/3	GN1/2	GN1/3	GN1/4	GN1/6	GN1/9	
external (mm)	650 x 530	325 x 530	325 x 354	325 x 265	325 x 176	162 x 265	162 x 176	108 x 176	
internal (mm)	625 x 505	300 x 505	300 x 329	300 x 240	300 x 151	137 x 240	137 x 151	83 x 151	
Gastronorm Depth	<b>200mm</b>	<b>GN2/1-200</b> £175	<b>GN1/1-200</b> £85	<b>GN2/3-200</b> £75	<b>GN1/2-200</b> £60	<b>GN1/3-200</b> £45	-	-	
	<b>150mm</b>	<b>GN2/1-150</b> £160	<b>GN1/1-150</b> £70	<b>GN2/3-150</b> £60	<b>GN1/2-150</b> £50	<b>GN1/3-150</b> £40	<b>GN1/4-150</b> £30	<b>GN1/6-150</b> £30	
	<b>100mm</b>	<b>GN2/1-100</b> £115	<b>GN1/1-100</b> £50	<b>GN2/3-100</b> £50	<b>GN1/2-100</b> £30	<b>GN1/3-100</b> £30	<b>GN1/4-100</b> £25	<b>GN1/6-100</b> £20	<b>GN1/9-100</b> £20
	<b>65mm</b>	<b>GN2/1-65</b> £90	<b>GN1/1-65</b> £40	<b>GN2/3-65</b> £35	<b>GN1/2-65</b> £30	<b>GN1/3-65</b> £25	<b>GN1/4-65</b> £25	<b>GN1/6-65</b> £20	<b>GN1/9-65</b> £15
	<b>40mm</b>	<b>GN2/1-40</b> £90	<b>GN1/1-40</b> £35	<b>GN2/3-40</b> £35	<b>GN1/2-40</b> £25	<b>GN1/3-40</b> £25	-	-	-
	<b>20mm</b>	<b>GN2/1-20</b> £65	<b>GN1/1-20</b> £35	<b>GN2/3-20</b> £30	<b>GN1/2-20</b> £25	<b>GN1/3-20</b> £20	<b>GN1/4-20</b> £20	-	-
<b>Lid</b>	-	<b>GL1</b> £35	<b>GL2/3</b> £30	<b>GL1/2</b> £20	<b>GL1/3</b> £20	<b>GL1/4</b> £15	<b>GL1/6</b> £15	<b>GL1/9</b> £15	

Bridging bars are required to use containers GN1/4 size or smaller in any Victor Bains Marie unit.

Order 1 x BRI008 for each GN multiple when using GN1/4 size containers

Order 2 x BRI008 for each GN multiple when using GN1/6 or GN1/9 size containers **BRI008CS - £15 each**

For full product specification see Victor product brochure or visit [www.victoronline.co.uk](http://www.victoronline.co.uk)

email: [sales@victormfg.co.uk](mailto:sales@victormfg.co.uk)

tel: 01274 722125

# HEATED DRAWERS



Hot Cupboards

## Heated drawer units

Six model choices. Heavy duty stainless steel construction. Thermostatic control. Removable drawers. Fan assisted heating module. Integral humidity tray (not HD40 or HD61). Supplied with 13 amp plug fitted. Containers not included - see page 6.

**Table Top - 2 Drawer**



**HD40TT2** £2,125  
405 x 680 x 440mm 0.5kW  
1 x GN1/1 - 65mm deep each drawer

**Mobile - 3 Drawer**



**HD75VM** £4,660  
760 x 700 x 900mm 1.5kW  
2 x GN1/1 - 100mm deep top & middle drawer  
2 x GN1/1 - 150mm deep bottom drawer

**Slide Under - 3 Drawer**



**HD75RU** £4,660  
760 x 650 x 850mm 1.5kW  
2 x GN1/1 - 150mm deep each drawer

**Slide Under - 2 Drawer**

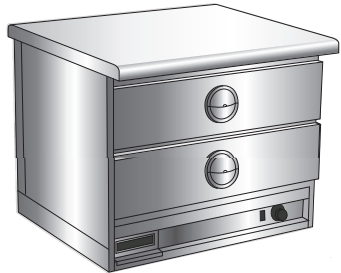

**HD75RU2** £4,015  
760 x 650 x 655mm 1.5kW  
2 x GN1/1 - 150mm deep each drawer

**Slide Under - 3 Drawer**



**HD60RU** £4,660  
610 x 780 x 850mm 1.5kW  
2 x GN1/1 - 150mm deep each drawer

**Slide Under - 4 Drawer**



**HD61** £3,435  
600 x 660 x 790mm 1.0kW  
1 x GN1/1 - 100mm deep each drawer

## Le Pass high capacity kitchen serveries

High capacity kitchen servery hot cupboards are created by combining the heated drawer system with heavy duty Peer & Sceptre hot cupboards forming a work station with a gastronorm capacity of up to 9 x GN1/1 containers. Heated drawer capacity 2 x GN1/1 containers, 150mm deep, in the bottom drawer & 2 x GN1/1 containers 100mm deep in the top and middle drawers. Option of two tier quartz heated gantry.

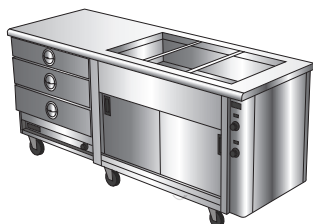

Standard models	1960 x 700 x 900mm		1960 x 700 x 900mm	
	Plain Top			3 pan Bains Marie
<b>PEERHD9F</b>	<b>£7,810</b>		<b>SCEPHD9F</b>	<b>£8,585</b>
2.5kW			4.0kW	
Pass through units	Plain Top		3 pan Bains Marie	
<b>PEDDHD9F</b>	<b>£8,000</b>		<b>SCDDHD9F</b>	<b>£9,085</b>
2.5kW			4.0kW	
<b>Models with gantry</b>	Plain Top		3 pan Bains Marie	
<b>PEERHD9FTT2Q</b>	<b>£9,990</b>		<b>SCEPHD9FTT2Q</b>	<b>£11,065</b>
5.5kW			7.0kW	
Pass through units	Plain Top		3 pan Bains Marie	
<b>PEDDHD9FTT2Q</b>	<b>£10,470</b>		<b>SCDDHD9FTT2Q</b>	<b>£11,550</b>
5.5kW			7.0kW	
<b>COMMANDO</b>	Commando plug & cable	<b>£205</b>		

For full product specification see Victor product brochure or visit [www.victoronline.co.uk](http://www.victoronline.co.uk)

email: [sales@victormfg.co.uk](mailto:sales@victormfg.co.uk)

tel: 01274 722125

**Hot Cupboards / Bains Marie - Heavy duty, electric**

A comprehensive range of plain top & Bains Marie hot cupboards built to the highest quality standards for maximum safety, ease of use and cleanability. Available in 4 standard lengths. Side wall mounted fan assisted heating module, digital temperature display, adjustable thermostatic control. Gastronorm compatible hot cupboard, four castors, two braked.

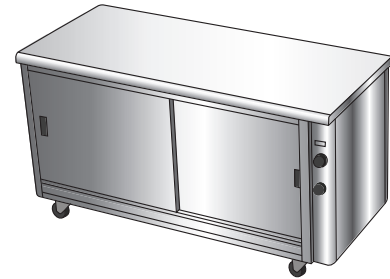
**PEERS - Plain top hot cupboards**

Electric	1205 x 700 x 900mm	1605 x 700 x 900mm	1905 x 700 x 900mm	2242 x 700 x 900mm
<b>Fan assisted</b> Two adjustable shelves	<b>PEER12Z</b> 2kW <b>£2,855</b>	<b>PEER16Z</b> 2kW <b>£3,100</b>	<b>PEER19Z</b> 2kW <b>£3,415</b>	<b>PEER22Z</b> 2kW <b>£3,740</b>
<b>Fan assisted pass through</b> Two adjustable shelves	<b>PEER12DZ</b> 2kW <b>£3,345</b>	<b>PEER16DZ</b> 2kW <b>£3,675</b>	<b>PEER19DZ</b> 2kW <b>£3,985</b>	<b>PEER22DZ</b> 2kW <b>£4,325</b>

**PEERS - two tier**

Electric	1205 x 700 x 1700mm	1605 x 700 x 1700mm	1905 x 700 x 1700mm
<b>Fan assisted two tier</b> Four adjustable shelves	<b>PEER12TZ</b> 4kW <b>£6,180</b>	<b>PEER16TZ</b> 4kW <b>£7,080</b>	<b>PEER19TZ</b> 4kW <b>£7,885</b>
<b>Fan assisted two tier pass through</b> Four adjustable shelves	<b>PEER12TDZ</b> 4kW <b>£7,150</b>	<b>PEER16TDZ</b> 4kW <b>£8,175</b>	<b>PEER19TDZ</b> 4kW <b>£9,035</b>

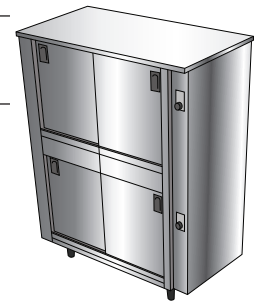
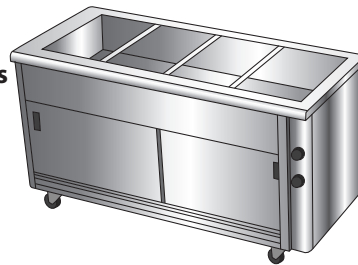
**SCEPTRES - Wet or dry Bains Marie hot cupboards**

**Electric**

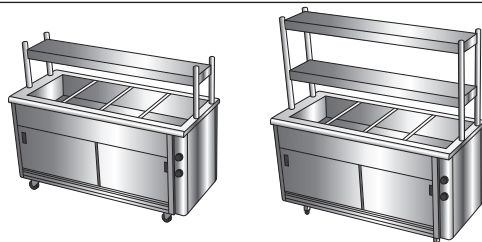
Electric	1205 x 700 x 900mm 3 x GN1/1	1605 x 700 x 900mm 4 x GN1/1	1905 x 700 x 900mm 5 x GN1/1	2242 x 700 x 900mm 6 x GN1/1
<b>Fan assisted</b> One adjustable shelf	<b>SCEP12Z</b> 2.5kW <b>£3,940</b>	<b>SCEP16Z</b> 3.8kW <b>£4,325</b>	<b>SCEP19Z</b> 4.40kW <b>£4,615</b>	<b>SCEP22Z</b> 5.00kW <b>£4,975</b>
<b>Fan assisted pass through</b> One adjustable shelf	<b>SCEP12DZ</b> 2.5kW <b>£4,430</b>	<b>SCEP16DZ</b> 3.8kW <b>£4,880</b>	<b>SCEP19DZ</b> 4.40kW <b>£5,190</b>	<b>SCEP22DZ</b> 5.00kW <b>£5,570</b>
<b>Open ambient cupboard</b> No shelf, doors extra	<b>SCEP12AMB</b> 1.5kW <b>£3,520</b>	<b>SCEP16AMB</b> 1.8kW <b>£3,965</b>	<b>SCEP19AMB</b> 2.4kW <b>£4,170</b>	<b>SCEP22AMB</b> 3.0kW <b>£4,390</b>



See page 9 for details of Kitchen Servery overshelves

**Units 3kW or under are supplied with a cable and 13 amp plug fitted.  
For units over 3.1kW, a commando plug & cable can be supplied at an extra cost of £200.**

**Optional Extras**

		1205mm	1605mm	1905mm	2242mm
<b>FEET</b>	Height adjustable feet in lieu of castors.....	<b>£90</b>			
<b>LOCK</b>	Locks to doors (per pair).....	<b>£190</b>			
<b>57-0080</b>	Swivel arm feed valve.....	<b>£320</b>			
<b>57-0145</b>	Swivel arm drain assembly.....	<b>£205</b>			
<b>BMVC2</b>	GN1/1 Carvery insert for Bains Marie.....	<b>£250</b>			
<b>FP00006</b>	GN1/1 Stainless steel filler plate.....	<b>£90</b>			
<b>COMMANDO</b>	Commando plug & cable.....	<b>£205</b>			
	Stainless steel interior	<b>£300</b>	<b>£320</b>	<b>£350</b>	<b>£400</b>
	Rolled upstand	<b>£135</b>	<b>£165</b>	<b>£200</b>	<b>£210</b>
	Bridging bars BRI008CS	<b>£45</b>	<b>£60</b>	<b>£75</b>	<b>£90</b>
	Additional shelf, bars & brackets	<b>£55</b>	<b>£55</b>	<b>£80</b>	<b>£90</b>
	Doors for ambient cupboard	<b>£435</b>	<b>£540</b>	<b>£555</b>	<b>£565</b>
	Tray rail - 3 rail square stainless steel - Fixed	<b>£330</b>	<b>£465</b>	<b>£510</b>	<b>£565</b>
	Tray rail - 3 rail square stainless steel - Dropdown	<b>£360</b>	<b>£500</b>	<b>£565</b>	<b>£625</b>

For full product specification see Victor product brochure or visit [www.victoronline.co.uk](http://www.victoronline.co.uk)

email: [sales@victormfg.co.uk](mailto:sales@victormfg.co.uk)

tel: 01274 722125

## Kitchen Servery gantrys

By combining the one, two or three tier, heated or ambient overshelves below with the heavy duty Bains Marie and Hot Cupboards on page 8 you can create a Kitchen servery station to meet the operational requirements of your food service system.

**Single tier with ambient shelf**

	Length	kW	Price
<b>KSSTA12</b>	1200	-	<b>£585</b>
<b>KSSTA16</b>	1600	-	<b>£605</b>
<b>KSSTA19</b>	1900	-	<b>£620</b>
<b>KSSTA22</b>	2200	-	<b>£635</b>

**Single tier with heated shelf**

	Length	kW	Price
<b>KSSTH12</b>	1200	1.0	<b>£975</b>
<b>KSSTH16</b>	1600	1.5	<b>£1020</b>
<b>KSSTH19</b>	1900	1.75	<b>£1,030</b>
<b>KSSTH22</b>	2200	2.0	<b>£1,050</b>

**Single tier with quartz heat lamps under shelf**

	Length	kW	Price
<b>KSSTQ12</b>	1200	0.9	<b>£1,115</b>
<b>KSSTQ16</b>	1600	1.2	<b>£1,270</b>
<b>KSSTQ19</b>	1900	1.5	<b>£1,395</b>
<b>KSSTQ22</b>	2200	1.8	<b>£1,555</b>

**Two tier with quartz heat lamps under top shelf, ambient lower shelf**

	Length	kW	Price
<b>KSTTQA12</b>	1200	0.9	<b>£1,395</b>
<b>KSTTQA16</b>	1600	1.2	<b>£1,560</b>
<b>KSTTQA19</b>	1900	1.5	<b>£1,720</b>
<b>KSTTQA22</b>	2200	1.8	<b>£1,870</b>

**Three tier with quartz heat lamps under top two shelves, ambient lower shelf**

	Length	kW	Price
<b>KS3T2QA12</b>	1200	1.8	<b>£2,185</b>
<b>KS3T2QA16</b>	1600	2.4	<b>£2,475</b>
<b>KS3T2QA19</b>	1900	3.0	<b>£2,790</b>
<b>KS3T2QA22</b>	2200	3.6	<b>£3,085</b>

**Two tier with quartz heat lamps under both shelves**

	Length	W	Price
<b>KSTT2Q12</b>	1200	1.8	<b>£1,915</b>
<b>KSTT2Q16</b>	1600	2.4	<b>£2,185</b>
<b>KSTT2Q19</b>	1900	3.0	<b>£2,470</b>
<b>KSTT2Q22</b>	2200	3.6	<b>£2,755</b>

**Three tier with quartz heat lamps under all shelves**

	Length	kW	Price
<b>KS3T3Q12</b>	1200	2.7	<b>£2,715</b>
<b>KS3T3Q16</b>	1600	3.6	<b>£3,130</b>
<b>KS3T3Q19</b>	1900	4.5	<b>£3,575</b>
<b>KS3T3Q22</b>	2200	5.4	<b>£3,985</b>

**Three tier with quartz heat lamps under all shelves**

	Length	kW	Price
<b>KS3T3QP12</b>	1200	2.7	<b>£2,715</b>
<b>KS3T3QP16</b>	1600	3.6	<b>£3,130</b>
<b>KS3T3QP19</b>	1900	4.5	<b>£3,575</b>
<b>KS3T3QP22</b>	2200	5.4	<b>£3,985</b>

### Options

Tab grabber

Sneeze screen - fitted each -

LED lamp under ambient shelves - each tier -

Dimmer to quartz lamps - each tier -

Auto-off switch to quartz lamps- each tier -

**£175**

**£325**

	1200mm 1 x 915mm	1600mm 1 x 1220mm	1900mm 2 x 915mm or 1 x 1220mm	2200mm
	<b>£185</b>	<b>£195</b>	<b>£370</b>	<b>£390</b>
	<b>£165</b>	<b>£185</b>	<b>£205</b>	<b>£255</b>
	<b>£170</b>	<b>£180</b>	<b>£195</b>	<b>£200</b>

For full product specification see Victor product brochure or visit [www.victoronline.co.uk](http://www.victoronline.co.uk)

email: [sales@victormfg.co.uk](mailto:sales@victormfg.co.uk)

tel: 01274 722125

**Banquetline - Heated units**

Constructed from stainless steel with robust all-round bumper, strong door latches and strong adjustable hinges. All units are mounted on 150mm heavy duty castors as standard with 2 braked. All units operate from a 13 amp supply. Heated units are factory set at 85°C, operator adjustable between 65°C and 95°C and are complete with a digital temperature read-out on the microprocessor control. Combination units require eutectic plates, not included in the price.

**Banquetline 30**

*Supplied with 2 shelves & supports and one push bar. Push bar adds 80mm to depth.*

<b>BL30H1- R</b>	Heated - one door	675 x 785 x 860mm	1.5kW	<b>£4,290</b>
<b>BL30H1- L</b>	Heated - one door	675 x 785 x 860mm	1.5kW	<b>£4,290</b>

**Banquetline 50 slim**

*Supplied with 4 shelves & supports and one push bar.*

<b>BL50H1S</b>	Heated - one door	755 x 700 x 1240mm	1.5kW	<b>£6,495</b>
----------------	-------------------	--------------------	-------	---------------

**Banquetline 50**

*Supplied with 4 shelves & supports and one push bar.*

<b>BL50H1</b>	Heated - one door	855 x 790 x 1240mm	1.5kW	<b>£6,495</b>
---------------	-------------------	--------------------	-------	---------------

**Banquetline 70**

*Supplied with 4 shelves & supports and one push bar.*

<b>BL70H1</b>	Heated - one door	855 x 790 x 1590mm	1.5kW	<b>£6,850</b>
---------------	-------------------	--------------------	-------	---------------

**Banquetline 81**

*Supplied with 7 shelves & supports.*

<b>BL81H1</b>	Heated - one door	530 x 675 x 1310mm	1.5kW	<b>£5,775</b>
---------------	-------------------	--------------------	-------	---------------

**Banquetline 100**

*Supplied with 4 shelves & supports and two push bars.*

<b>BL100H1</b>	Heated - one door	1070 x 760 x 1810mm	1.5kW	<b>£7,605</b>
<b>BL100H2</b>	Heated - two door	1070 x 760 x 1810mm	1.5kW	<b>£8,285</b>
<b>BL100HC2</b>	Combination heated/chill-two door	1070 x 760 x 1810mm	1.5kW	<b>£8,705</b>

**Banquetline 100 Maxi**

*Supplied with 4 shelves & supports and two push bars - Designed for use with 11" plates.*

<b>BL100H2MAX</b>	Heated - two door	1140 x 780 x 1900mm	1.5kW	<b>£8,635</b>
-------------------	-------------------	---------------------	-------	---------------

**Banquetline 200**

*Supplied with 8 shelves & supports and four push bars.*

<b>BL200H2</b>	Heated two doors	1950 x 760 x 1810mm	3kW	<b>£12,660</b>
<b>BL200H4</b>	Heated four doors	1950 x 760 x 1810mm	3kW	<b>£13,975</b>

**Extras**

Additional shelf supports per pair	<b>£30</b>
Additional shelves each	<b>£65</b>
Eutectic plates - 70-0060	<b>£175</b>
Plate covers for 10" plates - 69-0095	<b>£20</b>
Gastronorm containers	See page 6

**For full product specification see Victor product brochure or visit [www.victoronline.co.uk](http://www.victoronline.co.uk)**

email: [sales@victormfg.co.uk](mailto:sales@victormfg.co.uk)

tel: 01274 722125

**Banquetline cabinet capacities**

All capacities are based upon a 10" plate stacked using 60mm plate covers.

Part No.	Description	Max Length	Max Width	Height	No. of shelf positions	10" plates*	Eutectic plates	Gastronorm Container Capacity						
								GN 1/20	GN 1/40	GN 1/65	GN 1/100	GN 1/150	GN 1/200	
	<b>Banquetline 30</b>	675	865	860										
BL30H1-L/R	Heated one door				12	30	~	12	6	6	6	2	2	
	<b>Banquetline 50</b>	855	790	1240										
BL50H1	Heated one door				21	55	~	44	22	20	10	8	6	
	<b>Banquetline 50 slim</b>	755	700	1240										
BL50H1S	Heated one door				11	44	~	11	11	10	5	4	3	
	<b>Banquetline 70</b>	855	790	1590										
BL70H1	Heated one door				32	80	~	64	32	32	20	12	10	
	<b>Banquetline 81</b>	540	765	1650										
BL81H1	Heated one door (Pizza Unit)				7	~	~	7	7	7	7	7		
	<b>Banquetline 100</b>	1070	760	1810										
BL100H1	Heated one door				42	108	~	42	42	28	20	16	12	
BL100H2	Heated two doors				42	108	~	38	38	28	18	12	10	
BL100HC2	Combi- Heated/chill two doors				38	96	4	38	38	28	18	12	8	
	<b>Banquetline 200</b>	1950	760	1810										
BL200H2	Heated two doors				42	216	~	84	84	56	40	32	24	
BL200H4	Heated four doors				42	216	~	76	76	56	36	24	20	
	<b>Banquetline 100 MAXI</b>	1140	780	1900	Designed for use with 11" plates									
BL100H2MAX	Heated two door				38	120	~	76	38	26	16	14	12	

**Replacement shelf and bracket codes**

Unit	Shelf	Price	Bracket	Price/pair
<b>BL30 units</b>	<b>56-0288</b>	<b>£65</b>	<b>BKT0020</b>	<b>£30</b>
<b>BL50 slim</b>	<b>56-0285</b>	<b>£65</b>	<b>RSB007CA</b>	<b>£30</b>
<b>BL50 units</b>	<b>56-0288</b>	<b>£65</b>	<b>RSB008CA</b>	<b>£30</b>
<b>BL70 units</b>	<b>56-0288</b>	<b>£65</b>	<b>RSB008CA</b>	<b>£30</b>
<b>BL81 units</b>	<b>56-0170</b>	<b>£65</b>	<b>BKT0046</b>	<b>£30</b>
<b>BL100 units</b>	<b>56-0280</b>	<b>£65</b>	<b>RSB008CA</b>	<b>£30</b>
<b>BL100 Maxi</b>	<b>56-0226</b>	<b>£65</b>	<b>RSB011CA</b>	<b>£30</b>
<b>BL200 units</b>	<b>56-0280</b>	<b>£65</b>	<b>RSB008CA</b>	<b>£30</b>

**For full product specification see Victor product brochure or visit [www.victoronline.co.uk](http://www.victoronline.co.uk)**

email: [sales@victormfg.co.uk](mailto:sales@victormfg.co.uk)

tel: 01274 722125

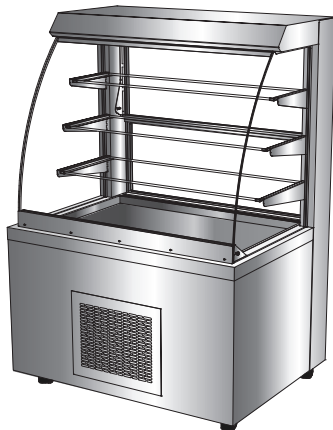
**Refrigerated Units - Design protected by GB Patent No. 2492998**

Victor Optimax refrigerated merchandising units are perfectly suited for delis, coffee shops, convenience stores and all food-to-go applications. These versatile displays facilitate the effective presentation of chilled produce whilst maintaining correct core product temperatures.

Designed to EN ISO 23953 standard, providing M1 cabinet class conditions and exceeding climate class 3 environment of 25°C at 60% RH. In use it will maintain the core product temperature of pre-chilled food below 5°C in ambient temperatures up to 27°C - 50% Relative Humidity.

	650 x 750 x 1445mm	1000 x 750 x 1445mm	1300 x 750 x 1445mm
<b>Assisted Service</b> <i>drop-down rear doors</i>	<b>RMR65E</b> £7,715 1.8kW	<b>RMR100E</b> £8,105 2.5kW	<b>RMR130E</b> £8,760 2.7kW
<b>Self Service</b> <i>solid back counter model controls to the rear</i>	<b>RMR65S</b> £7,545 1.8kW	<b>RMR100S</b> £7,945 2.5kW	<b>RMR130S</b> £8,585 2.7kW
<b>Self Service</b> <i>rear loading doors counter model, controls to the rear</i>	<b>RMR65SP</b> £7,610 1.8kW	<b>RMR100SP</b> £8,035 2.5kW	<b>RMR130SP</b> £8,685 2.7kW
<b>Self Service</b> <i>solid back wall model controls to the front</i>	<b>RMR65SW</b> £7,610 1.8kW	<b>RMR100SW</b> £8,035 2.5kW	<b>RMR130SW</b> £8,685 2.7kW

**Refrigerated Model Options**

	650 x 750 x 1445mm	1000 x 750 x 1445mm	1300 x 750 x 1445mm
Under Shelf Lighting	<b>RMR65-L</b> £475 extra	<b>RMR100-L</b> £500 extra	<b>RMR130-L</b> £645 extra
Ticket strips (set of 3)	<b>RMRTS65</b> ..... £210	<b>RMRTS100</b> .....£240	<b>RMRTS130</b> .....£275
Castor covers (St/St)	<b>RMCC65</b> ..... £80	<b>RMCC100</b> .....£90	<b>RMCC130</b> ..... £95
Metal security panel	<b>RMSP65</b> ..... £230	<b>RMSP100</b> .....£245	<b>RMSP130</b> .....£275
Base Fascia Panels	<b>RMBP65R</b> .....Inc	<b>RMBP100R</b> ..... Inc	<b>RMBP130R</b> .....Inc
St St or (PCS)	<i>Included in price above please specify St. St or Colour</i>		
Wood/Laminate	<b>RMBL65R</b> ..... £890	<b>RMBL100R</b> .. £1,020	<b>RMBL130R</b> .....£1,020
Unclad unit	<i>Reduction</i> .....-£110	<i>Reduction</i> ..... -£150	<i>Reduction</i> .....-£205

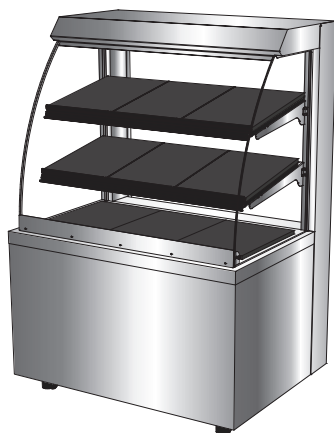
**Heated Units**

Victor Optimax heated merchandising units are perfectly suited for delis, coffee shops, convenience stores and all food-to-go applications. These versatile displays facilitate the effective presentation of heated produce whilst maintaining the product temperature.

Constructed using durable bright polished and satin finish stainless steel with toughened glass side screens. The temperature of each shelf can be adjusted and set independently between 65 and 95°C.

	650 x 750 x 1445mm	1000 x 750 x 1445mm	1300 x 750 x 1445mm
<b>Assisted Service</b> <i>Open to rear</i>	<b>RMH65E</b> £7,045 0.8kW	<b>RMH100E</b> £7,655 1.2kW	<b>RMH130E</b> £8,065 1.6kW
<b>Self Service</b> <i>Solid back counter model</i>	<b>RMH65S</b> £6,740 0.8kW	<b>RMH100S</b> £7,355 1.2kW	<b>RMH130S</b> £7,750 1.6kW
<b>Self Service</b> <i>Pass-Through</i>	<b>RMH65SP</b> £6,420 0.8kW	<b>RMH100SP</b> £7,010 1.2kW	<b>RMH130SP</b> £7,410 1.6kW
<b>Self Service</b> <i>Solid back wall model</i>	<b>RMH65SW</b> £6,740 0.8kW	<b>RMH100SW</b> £7,355 1.2kW	<b>RMH130SW</b> £7,750 1.6kW

**Heated Model Options**

Ticket strips (set of 2)	<b>RMHTS65</b> ..... £210	<b>RMHTS100</b> .....£240	<b>RMHTS130</b> ..... £275
Rear glass doors	<b>RMGD65</b> ..... £260	<b>RMGD100</b> .....£285	<b>RMGD130</b> .....£300
Castor covers (St/St)	<b>RMCC65</b> ..... £80	<b>RMCC100</b> .....£90	<b>RMCC130</b> ..... £95
Stainless steel doors			
to cupboard	<b>RMSSD65</b> ..... £325	<b>RMSSD100</b> .....£335	<b>RMSSD130</b> .....£345
Base Fascia panels	<b>RMBP65</b> .....-£110	<b>RMBP100</b> ..... -£150	<b>RMBP130</b> .....-£205
St St or (PCS)	<i>Included in price above please specify St. St or Colour</i>		
Wood/Laminate	<b>RMBL65A</b> ..... £640	<b>RMBL100A</b> .....£770	<b>RMBL130A</b> .....£770
Unclad unit	<i>Reduction</i> .....-£110	<i>Reduction</i> ..... -£150	<i>Reduction</i> .....-£205

**For full product specification see Victor product brochure or visit [www.victoronline.co.uk](http://www.victoronline.co.uk)**

email: [sales@victormfg.co.uk](mailto:sales@victormfg.co.uk)

tel: 01274 722125

**Optimax ambient units**

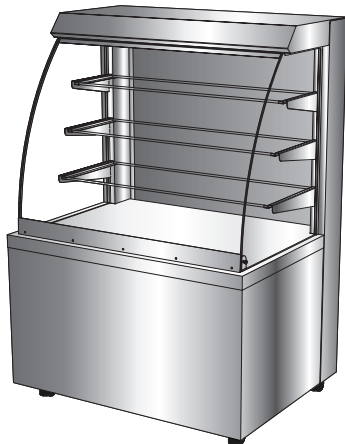

	650 x 750 x 1445mm	1000 x 750 x 1445mm	1300 x 750 x 1445mm
<b>Assisted Service</b> <i>Open to rear</i>	<b>RMA65E £4,060</b> 13W	<b>RMA100E £4,335</b> 21W	<b>RMA130E £4,620</b> 28W
<b>Self Service</b> <i>Solid back counter model</i>	<b>RMA65S £3,725</b> 13W	<b>RMA100S £4,015</b> 21W	<b>RMA130S £4,295</b> 28W
<b>Self Service</b> <i>Pass-through</i>	<b>RMA65SP £3,415</b> 13W	<b>RMA100SP £3,700</b> 21W	<b>RMA130SP £3,965</b> 28W

**Ambient Model Options**

	<b>RMR65-L £475</b> extra	<b>RMR100-L £500</b> extra	<b>RMR130-L £645</b> extra
Under Shelf Lighting			
Ticket Strips (set of 3).....	<b>RMRTS65 ..... £210</b>	<b>RMRTS100 .....£240</b>	<b>RMRTS130 .....£275</b>
Rear glass doors .....	<b>RMGD65 ..... £260</b>	<b>RMGD100 .....£285</b>	<b>RMGD130.....£300</b>
Castor covers (St/St).....	<b>RMCC65 ..... £80</b>	<b>RMCC100 .....£90</b>	<b>RMCC130 ..... £95</b>
Stainless steel doors to cupboard .....	<b>RMSSD65 ..... £325</b>	<b>RMSSD100.....£335</b>	<b>RMSSD130 .....£345</b>
Base Fascia Panels .....	<b>RMBP65 .....-£110</b>	<b>RMBP100 ..... -£150</b>	<b>RMBP130 .....-£205</b>
St St or (PCS).....	<i>Included in price above please specify St, St or Colour</i>		
Wood/Laminate .....	<b>RMBL65A ..... £640</b>	<b>RMBL100A.....£770</b>	<b>RMBL130A .....£770</b>
Unclad unit .....	<i>Reduction .....-£110</i>	<i>Reduction ..... -£150</i>	<i>Reduction .....-£205</i>

**Vista refrigerated retail displays**

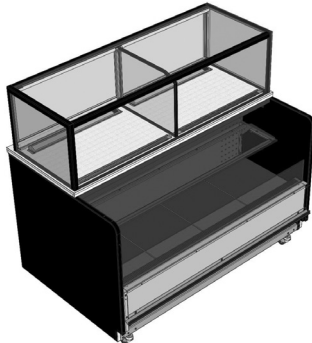

Vista refrigerated displays are perfectly suited for high capacity refrigerated and ambient display in delis, coffee shops, convenience stores and all food-to-go applications.

All units operate from a single 13 amp supply.

	1200 x 940 x 950/1350mm high	1500 x 940 x 1350mm high	1800 x 940 x 950/1350mm high
<b>Flexible refrigerated/ ambient top box</b>	<b>V12-F £8,580</b> 1.15kW	<b>V15-F £9,300</b> 1.15kW	<b>V18-F £9,790</b> 1.15kW
<b>Ambient top box</b>	<b>V12-A1-R1 £7,730</b> 1.15kW	<b>V15-A1-R1 £8,255</b> 1.15kW	<b>V18-A1-R1 £8,825</b> 1.15kW
<b>Plain top (No top box)</b>	<b>V12-A1-R2 £7,015</b> 1.15kW	<b>V15-A1-R2 £7,465</b> 1.15kW	<b>V18-A1-R2 £7,950</b> 1.15kW

**Optional extras**

Front Fascia panel.....	<b>F12-FP ..... £245</b>	<b>F15-FP .....£265</b>	<b>F18-FP .....£285</b>
Night blinds.....	<b>F12-NB ..... £110</b>	<b>F15-NB .....£115</b>	<b>F18-NB .....£160</b>

**EVOLUTION PLUS**

Victor Evolution plus units are available in heated & chilled versions suitable for self-service applications. They are perfectly suited for deli's, coffee shops, convenience stores and all food-to-go outlets.



**Refrigerated - Night blind & ticket strips included.**

<b>Self Service</b> <i>solid back wall model.....</i>	610 x 750 x 1950mm <b>SERT60SW ... £9,030</b> controls to the front 2.8kW thru vent	910 x 750 (850) x 1950mm <b>SERT90SW .. £9,425</b> 3.1kW thru vent
--	---	--

**Heated - Ticket strips included.**

<b>Self Service</b> <i>solid back wall model.....</i>	610 x 750 x 1950mm <b>SEHT60SW ... £6,995</b> controls to the front 2.8kW thru vent	910 x 750 (850) x 1950mm <b>SEHT90SW .. £8,030</b> 4.3kW thru vent
--	---	--

**Options**

Wire racks (per shelf).....	<b>SEHWT60 ..... £25</b>	<b>SEHWT90 .....£40</b>
Castor covers (St/St) .....	<b>SECC60..... £75</b>	<b>SECC90.....£80</b>



For full product specification see Victor product brochure or visit [www.victoronline.co.uk](http://www.victoronline.co.uk)

email: [sales@victormfg.co.uk](mailto:sales@victormfg.co.uk)

tel: 01274 722125

### Refrigerated Units

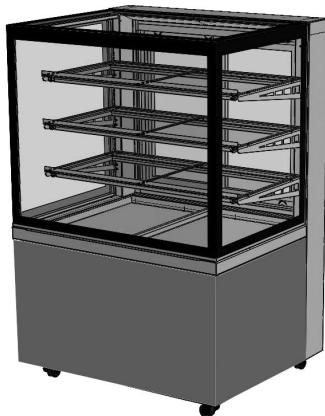

Victor Evolution displays are perfectly suited for delis, coffee shops, convenience stores and all food-to-go applications. These versatile displays facilitate the effective presentation of chilled produce whilst maintaining correct core product temperatures.

Refrigerated units are designed to EN ISO 23953 standard, providing M1 or M2 cabinet class conditions and exceeding climate class 3 environment of 25°C at 60% RH. In use will maintain core product temperature of pre-chilled food below 5°C/7°C in ambient temperatures up to 27°C - 50% Relative Humidity.

	600 x 750 x 1350mm	900 x 750 x 1350mm	1200 x 750 x 1350mm
<b>Assisted Service</b> <i>rear sliding doors</i>	<b>SER60E £8,780</b> 1.5kW thru vent	<b>SER90E £10,360</b> 2.0kW rear vent	<b>SER120E £11,440</b> 2.3kW rear vent
<b>Self Service</b> <i>rear loading doors</i>	<b>SER60SP £8,780</b> 1.5kW thru vent	<b>SER90SP £10,360</b> 2.0kW rear vent	<b>SER120SP £11,440</b> 2.3kW rear vent
<b>Self Service</b> <i>solid back wall model controls to the front</i>	<b>SER60SW £8,380</b> 1.5kW thru vent	<b>SER90SW £9,570</b> 2.0kW thru vent	<b>SER120SW £10,880</b> 2.3kW thru vent

#### Refrigerated Model Options

Roller night blind.....	<b>SENB60 .....£320</b>	<b>SENB90 .....£340</b>	<b>SENB120 .....£365</b>
Ticket strips (set of 3) .....	<b>SETS60 .....£40</b>	<b>SETS90 .....£65</b>	<b>SETS120 .....£65</b>
Castor covers (St/St) .....	<b>SECC60 .....£75</b>	<b>SECC90 .....£80</b>	<b>SECC120 .....£90</b>
Base Fascia panels			
St St or (PCS) .....	<b>SEBP60V .....Inc</b>	<b>SEBP90 ..... Inc</b>	<b>SEBP120 .....Inc</b>
Wood/Laminate thru vent .....	<b>SEBL60V .....£840</b>	<b>SEBL90V .....£950</b>	<b>SEBL120V .....£950</b>
Wood/Laminate rear vent.....		<b>SEBL90 .....£685</b>	<b>SEBL120 .....£685</b>
Un-clad unit .....	reduction ..... <b>-£110</b>	reduction ..... <b>-£150</b>	reduction ..... <b>-£205</b>

### Heated Units

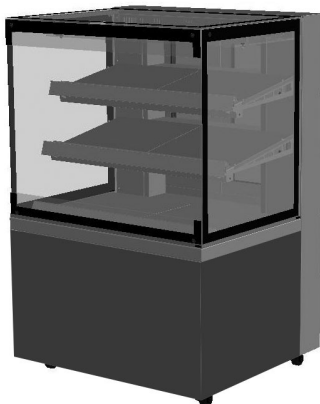

Heated units are constructed using durable bright polished and satin finish stainless steel with toughened glass side screens. The temperature of each shelf can be adjusted and set independently between 65° and 95°C.

	600 x 750 x 1350mm	900 x 750 x 1350mm	1200 x 750 x 1350mm
<b>Assisted Service</b> <i>rear hinged door/s</i>	<b>SEH60ED1 £5,965</b> 1.9kW	<b>SEH90ED2 £7,315</b> 2.9kW	<b>SEH120ED2 £8,160</b> 3.7kW
<b>Self Service</b> <i>rear hinged door/s</i>	<b>SEH60SPD1 £5,965</b> 1.8kW	<b>SEH90SPD2 £7,315</b> 2.9kW	<b>SEH120SPD2 £8,160</b> 3.7kW
<b>Self Service</b> <i>solid back wall model controls to the front</i>	<b>SEH60SW £5,680</b> 1.9kW	<b>SEH90SW £6,845</b> 2.9kW	<b>SEH120SW £7,660</b> 3.7kW

#### Heated Model Options

Ticket strips (set of 3) .....	<b>SETS60 .....£40</b>	<b>SETS90 .....£65</b>	<b>SETS120 .....£65</b>
Wire racks (per shelf).....	<b>SEHWT60 .....£25</b>	<b>SEHWT90 .....£40</b>	<b>SEHWT120 .....£65</b>
Humidity tray .....	<b>SEHHT60 .....£110</b>	<b>SEHHT90 .....£135</b>	<b>SEHHT120 .....£195</b>
Castor covers (St/St) .....	<b>SECC60 .....£75</b>	<b>SECC90 .....£80</b>	<b>SECC120 .....£90</b>
Base Fascia Panels			
St St or (PCS) .....	<b>SEBP60 .....Inc</b>	<b>SEBP90 ..... Inc</b>	<b>SEBP120 .....Inc</b>
Wood/Laminate .....	<b>SEBL60 .....£565</b>	<b>SEBL90 .....£685</b>	<b>SEBL120 .....£685</b>
Un-clad unit .....	reduction ..... <b>-£110</b>	reduction ..... <b>-£150</b>	reduction ..... <b>-£205</b>

### Ambient units



	600 x 750 x 1350mm	900 x 750 x 1350mm	1200 x 750 x 1350mm
<b>Assisted Service</b> <i>open to rear</i>	<b>SEA60E £3,175</b> 32W	<b>SEA90E £3,690</b> 58W	<b>SEA120E £4,065</b> 78W
<b>Self Service</b> <i>open to rear</i>	<b>SEA60SP £3,175</b> 32W	<b>SEA90SP £3,690</b> 58W	<b>SEA120SP £3,925</b> 78W
<b>Self Service</b> <i>solid back wall model</i>	<b>SEA60SW £3,290</b> 32W	<b>SEA90SW £3,775</b> 58W	<b>SEA120SW £4,025</b> 78W

#### Ambient Model Options

Ticket strips (set of 3) .....	<b>SETS60 .....£40</b>	<b>SETS90 .....£65</b>	<b>SETS120 .....£65</b>
Rear glass doors .....	<b>SEGD60 .....£245</b>	<b>SEGD90 .....£245</b>	<b>SEGD120 .....£280</b>
Castor covers (St/St) .....	<b>SECC60 .....£75</b>	<b>SECC90 .....£80</b>	<b>SECC120 .....£90</b>
Base Fascia panels			
St St or (PCS) .....	<b>SEBP60 .....Inc</b>	<b>SEBP90 ..... Inc</b>	<b>SEBP120 .....Inc</b>
Wood/Laminate .....	<b>SEBL60 .....£565</b>	<b>SEBL90 .....£685</b>	<b>SEBL120 .....£685</b>
Un-clad unit .....	reduction ..... <b>-£110</b>	reduction ..... <b>-£150</b>	reduction ..... <b>-£205</b>

For full product specification see Victor product brochure or visit [www.victoronline.co.uk](http://www.victoronline.co.uk)

email: [sales@victormfg.co.uk](mailto:sales@victormfg.co.uk)

tel: 01274 722125

## Cake Displays

Glass counter top displays, ideal for the ambient display of cakes and other confectionery products. Hygiene friendly design with a full glass screen and a food safe laminate base. Laminate base finishes include: beech, oak and walnut. Alternative finishes are available upon request.

**\*Net pricing only on Cake displays**

### Ambient cake display - Square glass

Model number	Dimensions	Price
VIC01SQ	993 x 662 x 670mm	£1,020
VIC02SQ	1293 x 662 x 670mm	£1,115
VIC03SQ	1493 x 662 x 670mm	£1,195



VIC02SQ



VIC02

### Ambient cake display - Curved glass

Model number	Dimensions	Price
VIC01	993 x 662 x 670mm	£1,160
VIC02	1293 x 662 x 670mm	£1,245
VIC03	1493 x 662 x 670mm	£1,325

### Ambient cake display with mid shelf - Square glass

Model number	Dimensions	Price
VIC01SQS	993 x 662 x 670mm	£1,110
VIC02SQS	1293 x 662 x 670mm	£1,200
VIC03SQS	1493 x 662 x 670mm	£1,290



VIC02SQS



VIC02S

### Ambient cake display with mid shelf - Curved glass

Model number	Dimensions	Price
VIC01S	993 x 662 x 670mm	£1,270
VIC02S	1293 x 662 x 670mm	£1,350
VIC03S	1493 x 662 x 670mm	£1,440

For full product specification see Victor product brochure or visit [www.victoronline.co.uk](http://www.victoronline.co.uk)

email: [sales@victormfg.co.uk](mailto:sales@victormfg.co.uk)

tel: 01274 722125

**Maxiline Eco Plus**

Victor Eco Plus multilevel refrigerated displays are **Energy Technology** listed offering **A grade** efficiency rated units. Available in two depths, three lengths and a choice of stainless steel or painted body panels, the units come complete with hinged doors, 4 adjustable shelves, all round LED illumination with customer proximity sensors. All units operate from a single 13 amp supply.

**Standard depth units - Doors to front**

900 x 750 x 1950mm	1000 x 750 x 1950mm	1200 x 750 x 1950mm	1500 x 750 x 1950mm
<i>Stainless steel exterior, painted back panel</i>			
MAXI090VDMT-P-GY-EP <b>£7,745</b>	MAXI100VDMT-P-GY-EP <b>£7,930</b>	MAXI120VDMT-P-GY-EP <b>£8,135</b>	MAXI150VDMT-P-GY-EP <b>£9,255</b>
<i>Painted exterior &amp; interior back panels</i>			
MAXI090VDMT-P-PA-EP <b>£7,860</b>	MAXI100VDMT-P-PA-EP <b>£8,040</b>	MAXI120VDMT-P-PA-EP <b>£8,245</b>	MAXI150VDMT-P-PA-EP <b>£9,370</b>

**Slimline units - Doors to front**

900 x 600 x 1950mm	1000 x 600 x 1950mm	1200 x 600 x 1950mm	1500 x 600 x 1950mm
<i>Stainless steel exterior, painted back panel</i>			
MAXI090VDST-P-GY-EP <b>£7,500</b>	MAXI100VDST-P-GY-EP <b>£7,630</b>	MAXI120VDST-P-GY-EP <b>£7,830</b>	MAXI150VDST-P-GY-EP <b>£8,940</b>
<i>Painted exterior &amp; interior back panels</i>			
MAXI090VDST-P-PA-EP <b>£7,610</b>	MAXI100VDST-P-PA-EP <b>£7,740</b>	MAXI120VDST-P-PA-EP <b>£7,940</b>	MAXI150VDST-P-PA-EP <b>£9,050</b>

**Optional Extras**

Castor Covers			
MAXI090V-CC <b>£90</b>	MAXI100V-CC <b>£90</b>	MAXI120V-CC <b>£105</b>	MAXI150V-CC <b>£115</b>

Maxiline

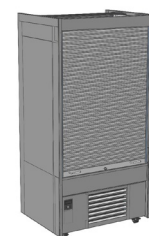
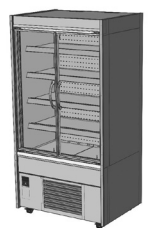
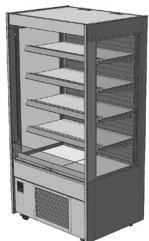
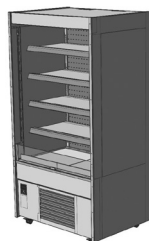
**Maxiline**

Victor Maxiline offers a comprehensive range of multilevel refrigerated displays, available in six model lengths, two depths units, can be supplied with a stainless steel, or painted finish or glazed side, night blinds, security shutters of double glazed lockable doors. Units come complete with 4 adjustable shelves, all round LED illumination and operate from either a single or 2 x 13 amp supply.

**Standard depth units.**

750mm deep by 1950mm high - units fitted with roller shutters are 2020mm high.

	Unit Length					
	600mm	900mm	1000mm	1200mm	1500mm	1800mm
<b>Standard 750mm deep unit St/St finish</b>	<b>£4,770</b>	<b>£5,485</b>	<b>£5,800</b>	<b>£6,080</b>	<b>£6,715</b>	<b>£8,535</b>

**Additional Options**

Glazed sides.....	<b>£205</b>	<b>£205</b>	<b>£205</b>	<b>£205</b>	<b>£205</b>	<b>£205</b>
Painted interior/exterior .....	<b>£110</b>	<b>£110</b>	<b>£110</b>	<b>£110</b>	<b>£110</b>	<b>£110</b>
Night blind.....	Inc.....	Inc.....	Inc.....	Inc.....	Inc.....	Inc.....
Hinged double glazed doors ....	<b>£680</b>	<b>£1,120</b>	<b>£1,135</b>	<b>£1,155</b>	<b>£1,610</b>	<b>£2,255</b>
Roller shutter.....	<b>£560</b>	<b>£615</b>	<b>£625</b>	<b>£780</b>	<b>£845</b>	<b>£920</b>

**Optional Extras**

Castor covers.....	<b>£80</b>	<b>£90</b>	<b>£90</b>	<b>£100</b>	<b>£110</b>	<b>£120</b>
--------------------	------------	------------	------------	-------------	-------------	-------------

**Slimline depth units.**

600mm deep by 1950mm high - units fitted with roller shutters are 2020mm high.

	Unit Length					
	600mm	900mm	1000mm	1200mm	1500mm	1800mm
<b>Slimline 600mm deep unit St/St finish</b>	<b>£4,595</b>	<b>£5,270</b>	<b>£5,575</b>	<b>£5,815</b>	<b>£6,485</b>	<b>£8,300</b>

**Additional Options**

Glazed sides.....	<b>£205</b>	<b>£205</b>	<b>£205</b>	<b>£205</b>	<b>£205</b>	<b>£205</b>
Painted interior/exterior .....	<b>£110</b>	<b>£110</b>	<b>£110</b>	<b>£110</b>	<b>£110</b>	<b>£110</b>
Night blind.....	Inc.....	Inc.....	Inc.....	Inc.....	Inc.....	Inc.....
Hinged double glazed doors ....	<b>£680</b>	<b>£1,120</b>	<b>£1,135</b>	<b>£1,155</b>	<b>£1,610</b>	<b>£2,255</b>
Roller shutter.....	<b>£560</b>	<b>£615</b>	<b>£625</b>	<b>£780</b>	<b>£845</b>	<b>£920</b>

**Optional Extras**

Castor covers.....	<b>£80</b>	<b>£90</b>	<b>£90</b>	<b>£100</b>	<b>£110</b>	<b>£120</b>
--------------------	------------	------------	------------	-------------	-------------	-------------

**MAXI-BSK465** (Impulse box).... **£110**

**A full model range listing is shown on page 16**

**For full product specification see Victor product brochure or visit [www.victoronline.co.uk](http://www.victoronline.co.uk)**

email: [sales@victormfg.co.uk](mailto:sales@victormfg.co.uk)

tel: 01274 722125

**Maxiline - Full model range listing**

Standard depth units - Night blind											
600 x 750 x 1950mm		900 x 750 x 1950mm		1000 x 750 x 1950mm		1200 x 750 x 1950mm		1500 x 750 x 1950mm		1800 x 750 x 1950mm	
<i>Bright annealed stainless steel panels</i>											
MAXI060VMT-P-ST	£4,765	MAXI090VMT-P-ST	£5,485	MAXI100VMT-P-ST	£5,795	MAXI120VMT-P-ST	£6,080	MAXI150VMT-P-ST	£6,715	MAXI180VMT-P-ST	£8,535
<i>Stainless steel exterior, dark grey painted back panel</i>											
MAXI060VMT-P-GY	£4,765	MAXI090VMT-P-GY	£5,485	MAXI100VMT-P-GY	£5,795	MAXI120VMT-P-GY	£6,080	MAXI150VMT-P-GY	£6,715	MAXI180VMT-P-GY	£8,535
<i>Painted exterior &amp; interior back panels</i>											
MAXI060VMT-P-PA	£4,880	MAXI090VMT-P-PA	£5,595	MAXI100VMT-P-PA	£5,910	MAXI120VMT-P-PA	£6,190	MAXI150VMT-P-PA	£6,830	MAXI180VMT-P-PA	£8,645
<i>Stainless steel panels, glazed sides</i>											
MAXI060VMT-G-ST	£4,975	MAXI090VMT-G-ST	£5,690	MAXI100VMT-G-ST	£6,005	MAXI120VMT-G-ST	£6,285	MAXI150VMT-G-ST	£6,925	MAXI180VMT-G-ST	£8,740
<i>Stainless steel exterior, dark grey painted back panel, glazed sides</i>											
MAXI060VMT-G-GY	£4,975	MAXI090VMT-G-GY	£5,690	MAXI100VMT-G-GY	£6,005	MAXI120VMT-G-GY	£6,285	MAXI150VMT-G-GY	£6,925	MAXI180VMT-G-GY	£8,740
<i>Painted exterior &amp; interior back panels, glazed sides</i>											
MAXI060VMT-G-PA	£5,085	MAXI090VMT-G-PA	£5,800	MAXI100VMT-G-PA	£6,115	MAXI120VMT-G-PA	£6,400	MAXI150VMT-G-PA	£7,035	MAXI180VMT-G-PA	£8,855

Standard depth units - Door/s to front											
600 x 750 x 1950mm		900 x 750 x 1950mm		1000 x 750 x 1950mm		1200 x 750 x 1950mm		1500 x 750 x 1950mm		1800 x 750 x 1950mm	
<i>Bright annealed stainless steel panels</i>											
MAXI060VDMT-P-ST	£5,450	MAXI090VDMT-P-ST	£6,605	MAXI100VDMT-P-ST	£6,935	MAXI120VDMT-P-ST	£7,235	MAXI150VDMT-P-ST	£8,325	MAXI180VDMT-P-ST	£10,790
<i>Stainless steel exterior, dark grey painted back panel</i>											
MAXI060VDMT-P-GY	£5,450	MAXI090VDMT-P-GY	£6,605	MAXI100VDMT-P-GY	£6,935	MAXI120VDMT-P-GY	£7,235	MAXI150VDMT-P-GY	£8,325	MAXI180VDMT-P-GY	£10,790
<i>Painted exterior &amp; interior back panels</i>											
MAXI060VDMT-P-PA	£5,560	MAXI090VDMT-P-PA	£6,715	MAXI100VDMT-P-PA	£7,045	MAXI120VDMT-P-PA	£7,350	MAXI150VDMT-P-PA	£8,440	MAXI180VDMT-P-PA	£10,905
<i>Stainless steel panels, glazed sides</i>											
MAXI060VDMT-G-ST	£5,655	MAXI090VDMT-G-ST	£6,810	MAXI100VDMT-G-ST	£7,190	MAXI120VDMT-G-ST	£7,445	MAXI150VDMT-G-ST	£8,535	MAXI180VDMT-G-ST	£11,000
<i>Stainless steel exterior, dark grey painted back panel, glazed sides</i>											
MAXI060VDMT-G-GY	£5,655	MAXI090VDMT-G-GY	£6,810	MAXI100VDMT-G-GY	£7,190	MAXI120VDMT-G-GY	£7,445	MAXI150VDMT-G-GY	£8,535	MAXI180VDMT-G-GY	£11,000
<i>Painted exterior &amp; interior back panels, glazed sides</i>											
MAXI060VDMT-G-PA	£5,765	MAXI090VDMT-G-PA	£6,925	MAXI100VDMT-G-PA	£7,250	MAXI120VDMT-G-PA	£7,555	MAXI150VDMT-G-PA	£8,645	MAXI180VDMT-G-PA	£11,110

Standard depth units - Roller Shutter											
600 x 750 x 2020mm		900 x 750 x 2020mm		1000 x 750 x 2020mm		1200 x 750 x 2020mm		1500 x 750 x 2020mm		1800 x 750 x 2020mm	
<i>Bright annealed stainless steel panels</i>											
MAXI060VMT-P-ST-RS	£5,330	MAXI090VMT-P-ST-RS	£6,100	MAXI100VMT-P-ST-RS	£6,425	MAXI120VMT-P-ST-RS	£6,865	MAXI150VMT-P-ST-RS	£7,560	MAXI180VMT-P-ST-RS	£9,455
<i>Stainless steel exterior, dark grey painted back panel</i>											
MAXI060VMT-P-GY-RS	£5,330	MAXI090VMT-P-GY-RS	£6,100	MAXI100VMT-P-GY-RS	£6,425	MAXI120VMT-P-GY-RS	£6,865	MAXI150VMT-P-GY-RS	£7,560	MAXI180VMT-P-GY-RS	£9,455
<i>Painted exterior &amp; interior back panels</i>											
MAXI060VMT-P-PA-RS	£5,440	MAXI090VMT-P-PA-RS	£6,210	MAXI100VMT-P-PA-RS	£6,535	MAXI120VMT-P-PA-RS	£6,975	MAXI150VMT-P-PA-RS	£7,670	MAXI180VMT-P-PA-RS	£9,565
<i>Stainless steel panels, glazed sides</i>											
MAXI060VMT-G-ST-RS	£5,535	MAXI090VMT-G-ST-RS	£6,305	MAXI100VMT-G-ST-RS	£6,630	MAXI120VMT-G-ST-RS	£7,070	MAXI150VMT-G-ST-RS	£7,765	MAXI180VMT-G-ST-RS	£9,660
<i>Stainless steel exterior, dark grey painted back panel, glazed sides</i>											
MAXI060VMT-G-GY-RS	£5,535	MAXI090VMT-G-GY-RS	£6,305	MAXI100VMT-G-GY-RS	£6,630	MAXI120VMT-G-GY-RS	£7,070	MAXI150VMT-G-GY-RS	£7,765	MAXI180VMT-G-GY-RS	£9,660
<i>Painted exterior &amp; interior back panels, glazed sides</i>											
MAXI060VMT-G-PA-RS	£5,645	MAXI090VMT-G-PA-RS	£6,420	MAXI100VMT-G-PA-RS	£6,740	MAXI120VMT-G-PA-RS	£7,180	MAXI150VMT-G-PA-RS	£7,880	MAXI180VMT-G-PA-RS	£9,770

Slimline units - Night blind											
600 x 600 x 1950mm		900 x 600 x 1950mm		1000 x 600 x 1950mm		1200 x 600 x 1950mm		1500 x 600 x 1950mm		1800 x 600 x 1950mm	
<i>Bright annealed stainless steel panels</i>											
MAXI060VST-P-ST	£4,595	MAXI090VST-P-ST	£5,270	MAXI100VST-P-ST	£5,575	MAXI120VST-P-ST	£5,815	MAXI150VST-P-ST	£6,485	MAXI180VST-P-ST	£8,300
<i>Stainless steel exterior, dark grey painted back panel</i>											
MAXI060VST-P-GY	£4,595	MAXI090VST-P-GY	£5,270	MAXI100VST-P-GY	£5,575	MAXI120VST-P-GY	£5,815	MAXI150VST-P-GY	£6,485	MAXI180VST-P-GY	£8,300
<i>Painted exterior &amp; interior back panels</i>											
MAXI060VST-P-PA	£4,705	MAXI090VST-P-PA	£5,385	MAXI100VST-P-PA	£5,685	MAXI120VST-P-PA	£5,925	MAXI150VST-P-PA	£6,595	MAXI180VST-P-PA	£8,415
<i>Stainless steel panels, glazed sides</i>											
MAXI060VST-G-ST	£4,805	MAXI090VST-G-ST	£5,480	MAXI100VST-G-ST	£5,780	MAXI120VST-G-ST	£6,020	MAXI150VST-G-ST	£6,690	MAXI180VST-G-ST	£8,510
<i>Stainless steel exterior, dark grey painted back panel, glazed sides</i>											
MAXI060VST-G-GY	£4,805	MAXI090VST-G-GY	£5,480	MAXI100VST-G-GY	£5,780	MAXI120VST-G-GY	£6,020	MAXI150VST-G-GY	£6,690	MAXI180VST-G-GY	£8,510
<i>Painted exterior &amp; interior back panels, glazed sides</i>											
MAXI060VST-G-PA	£4,915	MAXI090VST-G-PA	£5,590	MAXI100VST-G-PA	£5,895	MAXI120VST-G-PA	£6,130	MAXI150VST-G-PA	£6,800	MAXI180VST-G-PA	£8,620

Slimline units - Door/s to front											
600 x 600 x 1950mm		900 x 600 x 1950mm		1000 x 600 x 1950mm		1200 x 600 x 1950mm		1500 x 600 x 1950mm		1800 x 600 x 1950mm	
<i>Bright annealed stainless steel panels</i>											
MAXI060VDST-P-ST	£5,275	MAXI090VDST-P-ST	£6,395	MAXI100VDST-P-ST	£6,710	MAXI120VDST-P-ST	£6,970	MAXI150VDST-P-ST	£8,095	MAXI180VDST-P-ST	£10,560
<i>Stainless steel exterior, dark grey painted back panel</i>											
MAXI060VDST-P-GY	£5,275	MAXI090VDST-P-GY	£6,395	MAXI100VDST-P-GY	£6,710	MAXI120VDST-P-GY	£6,970	MAXI150VDST-P-GY	£8,095	MAXI180VDST-P-GY	£10,560
<i>Painted exterior &amp; interior back panels</i>											
MAXI060VDST-P-PA	£5,390	MAXI090VDST-P-PA	£6,505	MAXI100VDST-P-PA	£6,825	MAXI120VDST-P-PA	£7,080	MAXI150VDST-P-PA	£8,205	MAXI180VDST-P-PA	£10,670
<i>Stainless steel panels, glazed sides</i>											
MAXI060VDST-G-ST	£5,485	MAXI090VDST-G-ST	£6,600	MAXI100VDST-G-ST	£6,920	MAXI120VDST-G-ST	£7,175	MAXI150VDST-G-ST	£8,300	MAXI180VDST-G-ST	£10,765
<i>Stainless steel exterior, dark grey painted back panel, glazed sides</i>											
MAXI060VDST-G-GY	£5,485	MAXI090VDST-G-GY	£6,600	MAXI100VDST-G-GY	£6,920	MAXI120VDST-G-GY	£7,175	MAXI150VDST-G-GY	£8,300	MAXI180VDST-G-GY	£10,765
<i>Painted exterior &amp; interior back panels, glazed sides</i>											
MAXI060VDST-G-PA	£5,595	MAXI090VDST-G-PA	£6,710	MAXI100VDST-G-PA	£7,030	MAXI120VDST-G-PA	£7,285	MAXI150VDST-G-PA	£8,415	MAXI180VDST-G-PA	£10,880

Slimline units - Roller Shutter											
600 x 600 x 2020mm		900 x 600 x 2020mm		1000 x 600 x 2020mm		1200 x 600 x 2020mm		1500 x 600 x 2020mm		1800 x 600 x 2020mm	
<i>Bright annealed stainless steel panels</i>											
MAXI060VST-P-ST-RS	£5,155	MAXI090VST-P-ST-RS	£5,890	MAXI100VST-P-ST-RS	£6,200	MAXI120VST-P-ST-RS	£6,595	MAXI150VST-P-ST-RS	£7,330	MAXI180VST-P-ST-RS	£9,220
<i>Stainless steel exterior, dark grey painted back panel</i>											
MAXI060VST-P-GY-RS	£5,155	MAXI090VST-P-GY-RS	£5,890	MAXI100VST-P-GY-RS	£6,200	MAXI120VST-P-GY-RS	£6,595	MAXI150VST-P-GY-RS	£7,330	MAXI180VST-P-GY-RS	£9,220
<i>Painted exterior &amp; interior back panels</i>											
MAXI060VST-P-PA-RS	£5,265	MAXI090VST-P-PA-RS	£6,000	MAXI100VST-P-PA-RS	£6,315	MAXI120VST-P-PA-RS	£6,705	MAXI150VST-P-PA-RS	£7,440	MAXI180VST-P-PA-RS	£9,330
<i>Stainless steel panels, glazed sides</i>											
MAXI060VST-G-ST-RS	£5,365	MAXI090VST-G-ST-RS	£6,095	MAXI100VST-G-ST-RS	£6,410	MAXI120VST-G-ST-RS	£6,800	MAXI150VST-G-ST-RS	£7,535	MAXI180VST-G-ST-RS	£9,430
<i>Stainless steel exterior, dark grey painted back panel, glazed sides</i>											
MAXI060VST-G-GY-RS	£5,365	MAXI090VST-G-GY-RS	£6,095	MAXI100VST-G-GY-RS	£6,410	MAXI120VST-G-GY-RS	£6,800	MAXI150VST-G-GY-RS	£7,535	MAXI180VST-G-GY-RS	£9,430
<i>Painted exterior &amp; interior back panels, glazed sides</i>											
MAXI060VST-G-PA-RS	£5,475	MAXI090VST-G-PA-RS	£6,205	MAXI100VST-G-PA-RS	£6,520	MAXI120VST-G-PA-RS	£6,915	MAXI150VST-G-PA-RS	£7,645	MAXI180VST-G-PA-RS	£9,540

Optional Extras												
Castor Covers	MAXI060V-CC	£80	MAXI090V-CC	£90	MAXI100V-CC	£90	MAXI120V-CC	£100	MAXI150V-CC	£110	MAXI180V-CC	£120

**For full product specification see Victor product brochure or visit [www.victoronline.co.uk](http://www.victoronline.co.uk)**

email: [sales@victormfg.co.uk](mailto:sales@victormfg.co.uk)

tel: 01274 722125

**DELI REFRIGERATED DISPLAY (DRD)**

Low-level refrigerated retail displays, ideal for supermarkets. Supplied in manageable, modular sizes, they allow for easier transport and access into buildings with interchangeable configurations to suit different layouts.



Individual modules	Full units
DRD095V	DRD190V
DRD100V	DRD200V
DRD125V	DRD250V
DRD150V	DRD300V

DRD

Unit code	Dimensions	Power	Price
DRD095V.....	950 x 901 x 1200mm.....	2.6Kw.....	£7280
DRD100V.....	1000 x 901 x 1200mm.....	2.6Kw.....	£7320
DRD125V.....	1250 x 901 x 1200mm.....	2.6Kw.....	£7455
DRD150V.....	1500 x 901 x 1200mm.....	2.6Kw.....	£7720

Unit code	Dimensions	Power	Price
DRD190V.....	1900 x 901 x 1200mm.....	2.6Kw.....	£14,245
DRD200V.....	2000 x 901 x 1200mm.....	2.6Kw.....	£14,365
DRD250V.....	2500 x 901 x 1200mm.....	2.6Kw.....	£14,700
DRD300V.....	3000 x 901 x 1200mm.....	2.6Kw.....	£15,155

**For full product specification see Victor product brochure or visit [www.victoronline.co.uk](http://www.victoronline.co.uk)**

email: [sales@victormfg.co.uk](mailto:sales@victormfg.co.uk)

tel: 01274 722125

## Buffet Toppers

Variable heat control to base, stainless steel construction, removable and interchangeable tops, 300W quartz heat lamps.

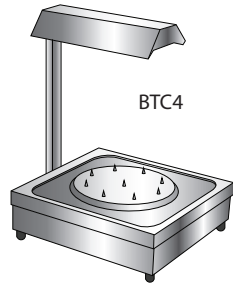

BTC4

	400 x 400 x 550mm		400 x 400 x 115mm		Spare top
<b>Carvery top</b>					
<b>BTC4</b>	<b>£1,045</b>	<b>BTC5</b>	<b>£725</b>	<b>BTCTOP</b>	<b>£295</b>
650W	With gantry	350W	No gantry		Spare top
<b>Glass top</b>					
<b>BTG4</b>	<b>£890</b>	<b>BTG5</b>	<b>£570</b>	<b>BTGTOP</b>	<b>£185</b>
650W	With gantry	350W	No gantry		Spare top
<b>Tiled top</b>					
<b>BTT4</b>	<b>£1,040</b>	<b>BTT5</b>	<b>£730</b>	<b>BTTTOP</b>	<b>£295</b>
650W	With gantry	350W	No gantry		Spare top
<b>Stainless Steel top</b>					
<b>BTP4</b>	<b>£825</b>	<b>BTP5</b>	<b>£500</b>	<b>BTPTOP</b>	<b>£70</b>
650W	With gantry	350W	No gantry		Spare top

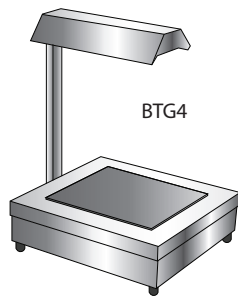

BTG4

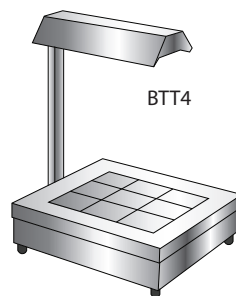

BTT4

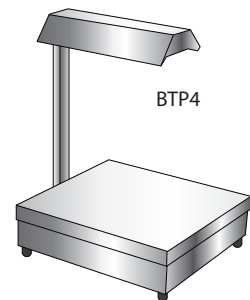

BTP4

## Hot lamp units

Heated base with infrared heat lamps

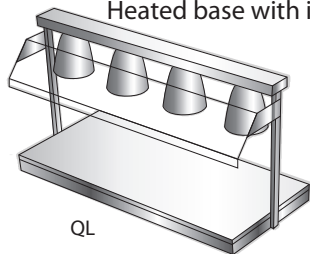

QL

	725 x 505 x 735mm		805 x 505 x 735mm		1275 x 615 x 735mm
<b>DL</b>	<b>£1,210</b>	<b>TL</b>	<b>£1,320</b>	<b>QL</b>	<b>£1,875</b>
1.3kW	2 lamps	1.6kW	3 lamps	2.9kW	4 lamps

## Hot plates

Stainless steel body and top and wooden carrying handles

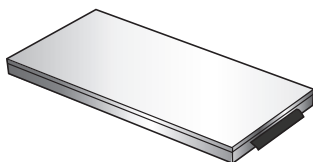

	600 x 300 x 115mm		800 x 300 x 115mm		1000 x 300 x 115mm		1000 x 500 x 115mm
<b>HP1</b>	<b>£495</b>	<b>HP2</b>	<b>£515</b>	<b>HP3</b>	<b>£690</b>	<b>HP4</b>	<b>£730</b>
0.3kW		0.4kW		0.85kW		0.85kW	

## Deli-toppers

### Refrigerated - One tier

Full height glass screen and side cheeks

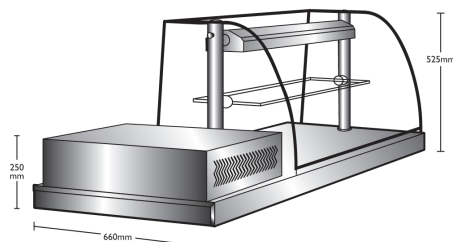

Part No	Dimensions	Loading	Price
<b>MRGL2</b>	1200 x 660 x 620mm	1.0kW	<b>£5,250</b>
<b>MRGL3</b>	1530 x 660 x 620mm	1.0kW	<b>£5,510</b>

### Refrigerated - One tier

Curved glass sneeze screen and side cheeks

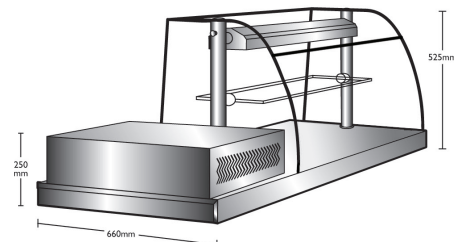

Part No	Dimensions	Loading	Price
<b>MRGL2W</b>	1200 x 660 x 620mm	1.0kW	<b>£5,010</b>
<b>MRGL3W</b>	1530 x 660 x 620mm	1.0kW	<b>£5,275</b>

For full product specification see Victor product brochure or visit [www.victoronline.co.uk](http://www.victoronline.co.uk)

email: [sales@victormfg.co.uk](mailto:sales@victormfg.co.uk)

tel: 01274 722125

**Deli Toppers**

A range of coordinated heated, refrigerated and ambient stainless steel and glass displays.

**Heated - Stainless steel top**

Full height glass screen and side cheeks

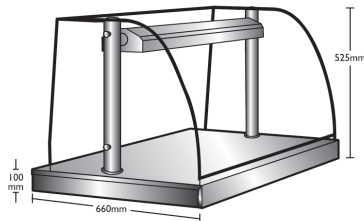

Part No	Dimensions	Loading	Price
<b>MHPL2</b>	850 x 660 x 620mm	1.1kW	<b>£2,825</b>
<b>MHPL3</b>	1177 x 660 x 620mm	1.9kW	<b>£3,100</b>
<b>MHPL4</b>	1504 x 660 x 620mm	2.7kW	<b>£3,465</b>

**Heated - Stainless steel top**

Curved glass sneeze screen and side cheeks

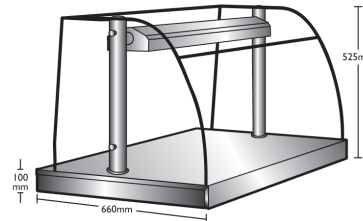

Part No	Dimensions	Loading	Price
<b>MHPL2W</b>	850 x 660 x 620mm	1.1kW	<b>£2,595</b>
<b>MHPL3W</b>	1177 x 660 x 620mm	1.9kW	<b>£2,890</b>
<b>MHPL4W</b>	1504 x 660 x 620mm	2.7kW	<b>£3,200</b>

**EXTRAS** Angled Deck Panels, GN1/1 size - **MHDP1** £70 each

**Heated - Bains Marie top**

Full height glass screen and side cheeks

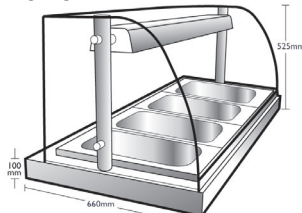

Part No	Dimensions	Loading	Price
<b>MHBM2</b>	850 x 660 x 620mm	1.1kW	<b>£2,985</b>
<b>MHBM3</b>	1177 x 660 x 620mm	1.9kW	<b>£3,360</b>
<b>MHBM4</b>	1504 x 660 x 620mm	2.7kW	<b>£3,745</b>

**Heated - Bains Marie top**

Curved glass sneeze screen and side cheeks

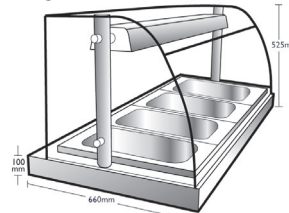

Part No	Dimensions	Loading	Price
<b>MHBM2W</b>	850 x 660 x 620mm	1.1kW	<b>£2,750</b>
<b>MHBM3W</b>	1177 x 660 x 620mm	1.9kW	<b>£3,135</b>
<b>MHBM4W</b>	1504 x 660 x 620mm	2.7kW	<b>£3,485</b>

**EXTRAS** Inclined display collar 2 pan - **MAIC2** £195

3 pan - **MAIC3** £225 4 pan - **MAIC4** £270

**Ambient - Two tier**

Full height glass screen and side cheeks

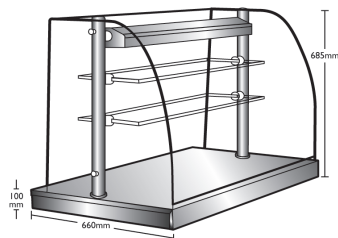

Part No	Dimensions	Loading	Price
<b>MAGH3</b>	1177 x 660 x 780mm	15W	<b>£3,455</b>
<b>MAGH4</b>	1504 x 660 x 780mm	30W	<b>£3,735</b>

**Ambient - Two tier**

Curved glass sneeze screen and side cheeks

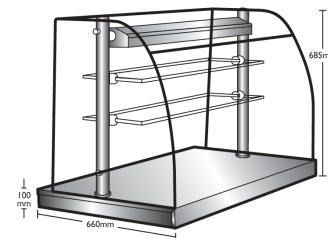

Part No	Dimensions	Loading	Price
<b>MAGH2W</b>	850 x 660 x 780mm	15W	<b>£2,965</b>
<b>MAGH3W</b>	1177 x 660 x 780mm	15W	<b>£3,225</b>
<b>MAGH4W</b>	1504 x 660 x 780mm	30W	<b>£3,415</b>

**Ambient - One tier**

Full height glass screen and side cheeks

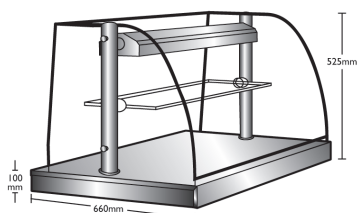

Part No	Dimensions	Loading	Price
<b>MAGL2</b>	850 x 660 x 620mm	15W	<b>£2,705</b>
<b>MAGL3</b>	1177 x 660 x 620mm	15W	<b>£2,930</b>
<b>MAGL4</b>	1504 x 660 x 620mm	30W	<b>£3,130</b>

**Ambient - One tier**

Curved glass sneeze screen and side cheeks

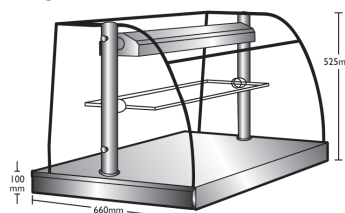

Part No	Dimensions	Loading	Price
<b>MAGL2W</b>	850 x 660 x 620mm	15W	<b>£2,470</b>
<b>MAGL3W</b>	1177 x 660 x 620mm	15W	<b>£2,690</b>
<b>MAGL4W</b>	1504 x 660 x 620mm	30W	<b>£2,865</b>

For full product specification see Victor product brochure or visit [www.victoronline.co.uk](http://www.victoronline.co.uk)

email: [sales@victormfg.co.uk](mailto:sales@victormfg.co.uk)

tel: 01274 722125

## Heated display units

### Stainless steel base

Heated base with 300W quartz heat lamps in gantry / sneeze screen. Matches the chilled display unit illustrated below.

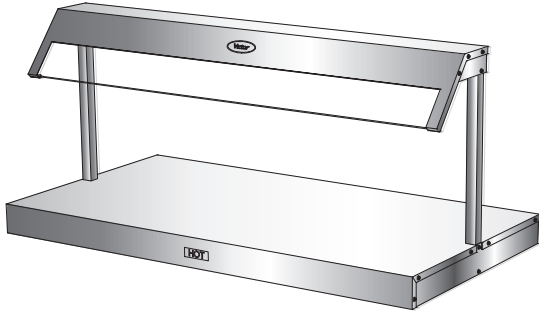

Part No	Dimensions	Loading	Price
<b>HDU20Z</b>	2 x GN1/1 - 780 x 580 x 520mm	1.35kW	<b>£895</b>
<b>HDU30Z</b>	3 x GN1/1 - 1110 x 580 x 520mm	2.0kW	<b>£1,105</b>
<b>HDU40Z</b>	4 x GN1/1 - 1435 x 580 x 520mm	2.2kW	<b>£1,385</b>
<b>BMCV5</b>	GN1/1 cradle container, spiked carvery pad		<b>£260</b>

### Heated glass base

Heated glass base with 300W quartz heat lamps in gantry / sneeze screen. Matches the chilled display unit illustrated below.

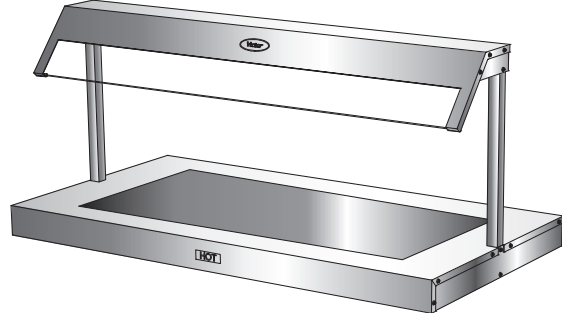

Part No	Dimensions	Loading	Price
<b>HDU20ZG</b>	2 x GN1/1 - 780 x 580 x 520mm	1.35kW	<b>£1,200</b>
<b>HDU30ZG</b>	3 x GN1/1 - 1110 x 580 x 520mm	2.0kW	<b>£1,415</b>
<b>HDU40ZG</b>	4 x GN1/1 - 1435 x 580 x 520mm	2.2kW	<b>£1,730</b>
<b>BMCV5</b>	GN1/1 cradle container, spiked carvery pad		<b>£260</b>

### Stainless steel well

With illuminated gantry / sneeze screen supplied with 3 Eutectic plates. Matches the heated display units HDU range illustrated above.

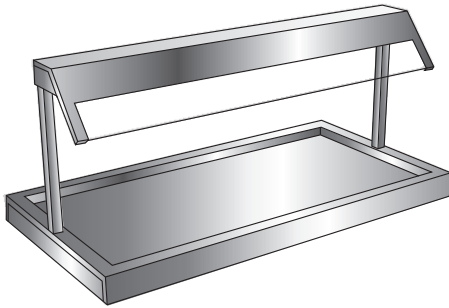

Part No	Dimensions	Loading	Price
<b>CDU30</b>	3 x GN1/1 - 1110 x 580 x 520mm	15W	<b>£1,425</b>
<b>Extras</b>			
<b>GN1/1 - 20mm</b>	Gastronorm flat (3 required)		<b>£35 each</b>

## Hot food merchandising units

### Pies/savoury products

470 x 470 x 790mm high 1.5 kW adjustable thermostat control.



Part No	Price
<b>HMU50</b> Complete with 3 tier wire rack	<b>£1,285</b>
<b>HMU50DD</b> With 3 tier wire rack and 2 doors	<b>£1,385</b>

### Pizza Units

470 x 470 x 790mm high 1.5 kW adjustable thermostat control.

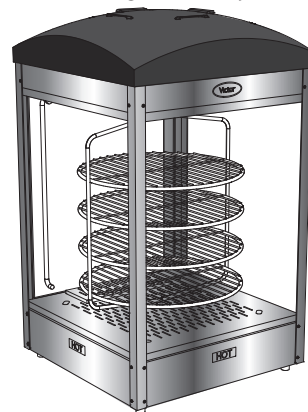

Part No	Price
<b>HMU50PIZM</b> Com. with 4 tier manually rotating rack	<b>£1,340</b>
<b>HMU50PIZMDD</b> With 4 tier manually rotating rack 2 doors	<b>£1,425</b>
<b>HMU50PIZA</b> Complete with 4 tier electric rotating rack	<b>£1,505</b>
<b>HMU50PIZADD</b> With 4 tier electric rotating rack 2 doors	<b>£1,620</b>

For full product specification see Victor product brochure or visit [www.victoronline.co.uk](http://www.victoronline.co.uk)

email: [sales@victormfg.co.uk](mailto:sales@victormfg.co.uk)

tel: 01274 722125

## Caribbean Toppers - Heated models

Heavy duty stainless steel construction - all fitted with dimmer to heat lamps and variable temperature control to base.

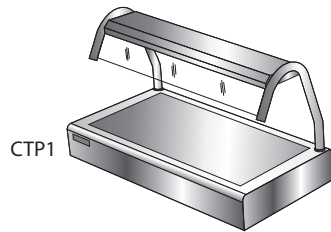

CTP1

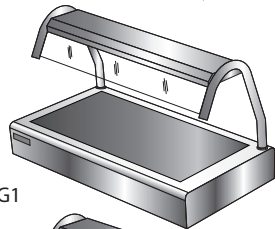

CTG1

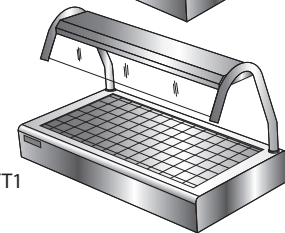

CTT1

**EXTRAS:**

- DHTP1** GN1/1 Tiled insert .....£355
- BMCV1** GN1/1 Carvery insert/Gravy dish for BM.....£300

	800 x 650 x 635mm		1200 x 650 x 635mm
Stainless steel top			
<b>CTP2</b>	<b>£2,865</b>	<b>CTP1</b>	<b>£3,075</b>
1.35kW		2.4kW	
Glass top			
<b>CTG2</b>	<b>£3,010</b>	<b>CTG1</b>	<b>£3,675</b>
1.1kW		1.9kW	
Tiled top			
<b>CTT2</b>	<b>£3,605</b>	<b>CTT1</b>	<b>£3,840</b>
1.35kW		2.4kW	
Tiled carvery top - c/w one interchangeable carvery pad and tiled insert			
		<b>CTC1</b>	<b>£4,040</b>
		2.4kW	
Bain Marie top - containers not included			
<b>CTB2</b>	<b>£2,680</b>	<b>CTB1</b>	<b>£2,830</b>
1.35kW		2.4kW	
		<b>PAD002CQ</b> Spare carvery pad	<b>£295</b>
		<b>AA-T100</b> Spare tiled insert	<b>£325</b>

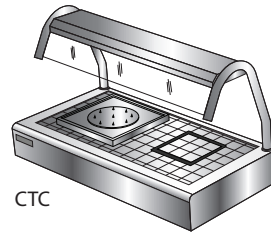

CTC

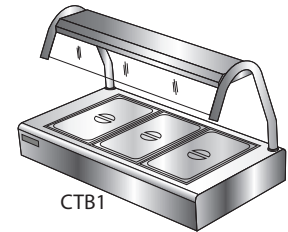

CTB1

- BMCV2** GN1/1 Carvery insert for Bains Marie .....£250
- DHCP1** GN1/1 Glass insert .....£325

## Pie heaters

Stainless steel construction with three wire shelves, thermostatic control.

### Counter top units

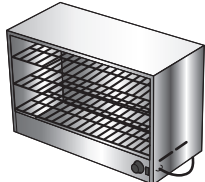

	725 x 350 x 490mm		760 x 510 x 640mm
<b>CU</b>	<b>£895</b>	<b>SPM75</b>	<b>£1,370</b>
0.7kW	door to front	1.0kW	doors both sides

### Floor Standing units



	1125 x 450 x 900mm
<b>HC31SSLGH4</b>	<b>£2,730</b>
2.2kW	4 shelves

## Burger chutes

Stainless steel construction with inclined heated shelves LED illumination.

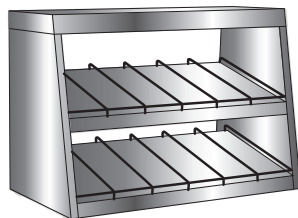

	720 x 600 x 755mm		1050 x 600 x 755mm
<b>BC20</b>	<b>£2,270</b>	<b>BC30</b>	<b>£2,490</b>
2.0kW		3.0kW	

## Stadia hot food cabinet

Stainless steel construction with inclined heated shelves & lift up doors front and rear.

	800 x 600 x 755mm
<b>BC21</b>	<b>£3,655</b>
2.5kW	

Toppers

For full product specification see Victor product brochure or visit [www.victoronline.co.uk](http://www.victoronline.co.uk)

email: [sales@victormfg.co.uk](mailto:sales@victormfg.co.uk)

tel: 01274 722125

## Caribbean - Heated modules

### Plain top hot cupboard

Hot cupboard - Fan assisted

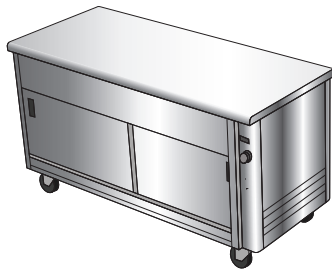

Available in coloured plastic coated steel or stainless steel finish, either mobile on castors or static on height adjustable feet. Stainless steel tops with radius to front and rear edge, Hot cupboards complete with digital temperature readout and one wire shelf.  
Can be supplied with a choice of gantry styles - see page 22.

	1206 x 700 x 900mm	1606 x 700 x 900mm	1906 x 700 x 900mm
base unit			
<b>CARIB5.212</b>	<b>£3,650</b>	<b>CARIB5.216</b>	<b>£4,205</b>
		<b>CARIB5.219</b>	<b>£4,475</b>
1.0kW		2.0kW	2.0W
<b>CARIB16.412D</b> add £525		<b>CARIB16.416D</b> add £740	<b>CARIB16.419D</b> add £750

Drop down tray slide

### Bains Marie hot cupboard

Wet or dry heat Bains Marie with fan assisted hot cupboard under - Containers not included.

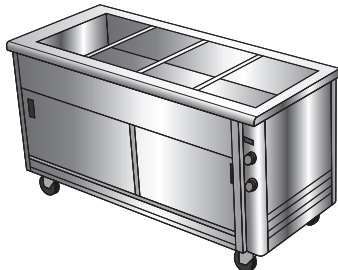

	1206 x 700 x 900mm	1606 x 700 x 900mm	1906 x 700 x 900mm
base unit			
<b>CARIB2.412</b>	<b>£5,110</b>	<b>CARIB2.416</b>	<b>£5,610</b>
		<b>CARIB2.419</b>	<b>£6,105</b>
2.1kW	3 x GN1/1	3.9kW	4 x GN1/1
		4.3kW	5 x GN1/1
heated gantry			
<b>GANSY12Q</b>	<b>£1,610</b>	<b>GANSY16Q</b>	<b>£1,690</b>
		<b>GANSY19Q</b>	<b>£1,800</b>
0.9kW		1.2kW	1.5kW
<b>CARIB16.412D</b> add £525		<b>CARIB16.416D</b> add £740	<b>CARIB16.419D</b> add £750

Drop down tray slide

### Heated tiled top hot cupboard

Hot cupboard - Fan assisted with flush durable heated tiled surface in a choice of colours.

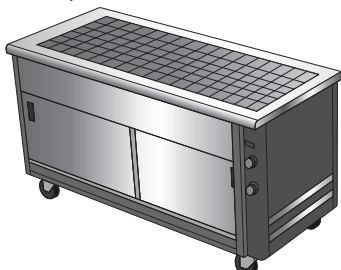

	1206 x 700 x 900mm	1606 x 700 x 900mm	1906 x 700 x 900mm
base unit			
<b>CARIB3.2A12</b>	<b>£5,570</b>	<b>CARIB3.2A16</b>	<b>£6,340</b>
		<b>CARIB3.2A19</b>	<b>£6,975</b>
2.1kW		3.9kW	4.3kW
heated gantry			
<b>GANSY12Q</b>	<b>£1,610</b>	<b>GANSY16Q</b>	<b>£1,690</b>
		<b>GANSY19Q</b>	<b>£1,800</b>
0.9kW		1.2kW	1.5kW
<b>CARIB16.412D</b> add £525		<b>CARIB16.416D</b> add £740	<b>CARIB16.419D</b> add £750

Drop down tray slide

### Heated glass top hot cupboard

Hot cupboard - Fan assisted with independently controlled heated glass pads to top.

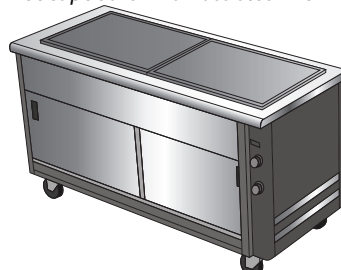

	1206 x 700 x 900mm	1606 x 700 x 900mm	1906 x 700 x 900mm
base unit			
<b>CARIB3.2B12</b>	<b>£5,570</b>	<b>CARIB3.2B16</b>	<b>£6,600</b>
		<b>CARIB3.2B19</b>	<b>£7,210</b>
2.0kW		3.0kW	3.5kW
heated gantry			
<b>GANSY12Q</b>	<b>£1,610</b>	<b>GANSY16Q</b>	<b>£1,690</b>
		<b>GANSY19Q</b>	<b>£1,800</b>
0.9kW		1.2kW	1.5kW
<b>CARIB16.412D</b> add £525		<b>CARIB16.416D</b> add £740	<b>CARIB16.419D</b> add £750

Drop down tray slide

### Carvery tiled top hot cupboard

Hot cupboard - Fan assisted with durable heated tiled surface in a choice of colours fitted with removable carvery pads.

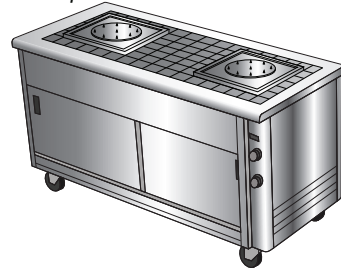

	1206 x 700 x 900mm	1606 x 700 x 900mm	1906 x 700 x 900mm
base unit			
<b>CARIB4.212</b>	<b>£5,895</b>	<b>CARIB4.216</b>	<b>£7,435</b>
		<b>CARIB4.219</b>	<b>£8,020</b>
2.1kW	1 pad	3.9kW	2 pads
		4.3kW	2 pads
heated gantry			
<b>GANSY12Q</b>	<b>£1,610</b>	<b>GANSY16Q</b>	<b>£1,690</b>
		<b>GANSY19Q</b>	<b>£1,800</b>
0.9kW		1.2kW	1.5kW
<b>CARIB16.412D</b> add £525		<b>CARIB16.416D</b> add £740	<b>CARIB16.419D</b> add £750

Drop down tray slide

For full product specification see Victor product brochure or visit [www.victoronline.co.uk](http://www.victoronline.co.uk)

email: [sales@victormfg.co.uk](mailto:sales@victormfg.co.uk)

tel: 01274 722125

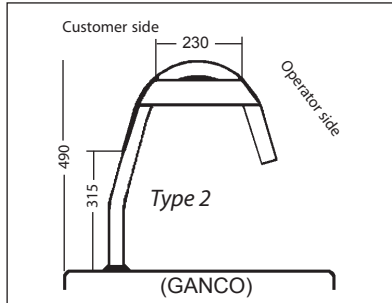

**Caribbean round tube (GANCO)**  
(Dimmer to quartz lamps)

Length	800	1200	1600	1900
Quartz	£1,605	£1,655	£1,725	£1,785
kW	0.6	0.9	1.2	1.5
LED	£1,290	£1,290	£1,325	£1,380

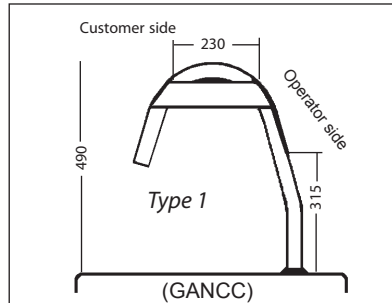

**Caribbean round tube (GANCC)**  
(Dimmer to quartz lamps)

Length	800	1200	1600	1900
Quartz	£1,605	£1,655	£1,725	£1,785
kW	0.6	0.9	1.2	1.5
LED	£1,290	£1,290	£1,325	£1,380

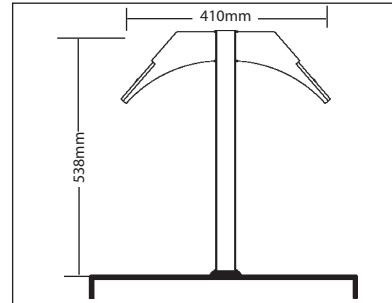

**Caribbean Island gantry (GANDB)**  
(Dimmer to quartz lamps)

Length	1200	1600	1900
Quartz	£1,575	£1,725	£1,785
kW	0.9	1.2	1.5
LED	£1,355	£1,390	£1,420

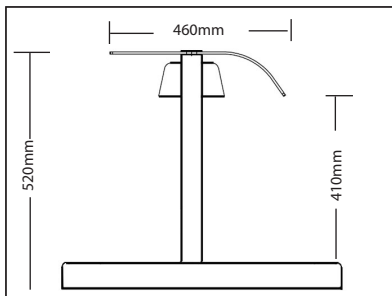

**Caribbean curved glass gantry (GANSY)**  
(Dimmer to quartz lamps)

Length	900	1200	1600	1900
Quartz	£1,610	£1,610	£1,690	£1,800
kW	0.6	0.9	1.2	1.5
LED	£1,475	£1,475	£1,560	£1,660
Shelf	£260	£260	£300	£340

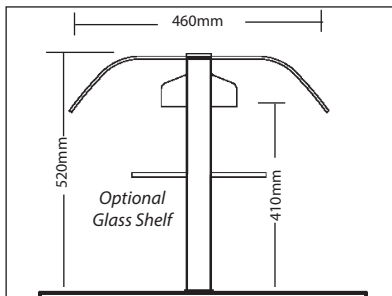

**Caribbean Island glass gantry (GANIS)**  
(Dimmer to quartz lamps)

Length	1200	1600	1900
Quartz	£1,670	£1,760	N/A
kW	0.9	1.2	N/A
LED	£1,535	£1,620	N/A
Shelf	£260	£300	

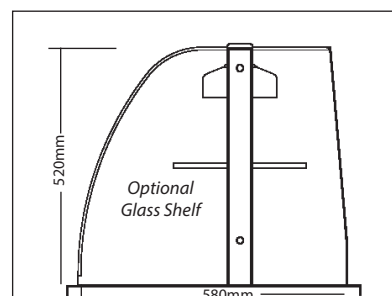

**Curved glass screen (GANDL)**  
(Dimmer to quartz lamps)

Length	1200	1600
Quartz	£2,060	£2,225
kW	0.9	1.2
LED	£1,735	£1,785
Shelf	£260	£300
Side Cheeks(Pr)		£360

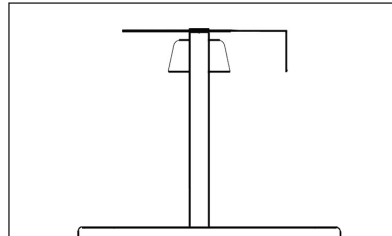

**Flat Glass Sneeze Screen (GANFGS)**

Length	900	1200	1600	1900
Quartz	£1,610	£1,610	£1,690	£1,800
kW	0.6	0.9	1.2	1.5
LED	£1,475	£1,475	£1,560	£1,660
Shelf	£260	£260	£300	£340

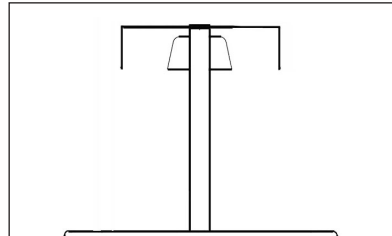

**Flat Glass Island Screen (GANFIS)**

Length	900	1200	1600	1900
Quartz	£1,670	£1,670	£1,760	£1,860
kW	0.6	0.9	1.2	1.5
LED	£1,535	£1,535	£1,620	£1,725
Shelf	£260	£260	£300	£340

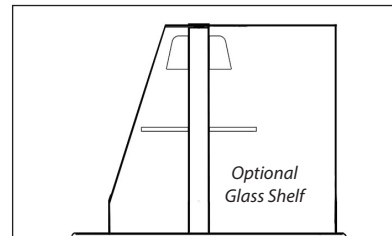

**Flat Glass Full Screen (GANFGF)**

Length	900	1200	1600	1900
Quartz	£1,785	£1,785	£1,925	£2,060
kW	0.6	0.9	1.2	1.5
LED	£1,420	£1,420	£1,475	£1,515
Shelf	£260	£260	£300	£340

**STAINLESS STEEL SQUARE TUBE (CARIB16.1)**

	800/1200	1600	1900
Drop down	£360	£500	£565
Fixed	£330	£465	£515
<b>Tray Storage</b>			
Drop down	£360		
Fixed	£330		
<b>STAINLESS STEEL ROUND BAR 38mm (CARIB16.4)</b>			
	800/1200	1600	1900
Drop down	£525	£740	£750
Fixed	£500	£710	£740
<b>Tray Storage</b>			
Drop down	£525		
Fixed	£500		

**SOLID STAINLESS STEEL EMBOSSED (CARIB16.3)**

	800/1200	1600	1900
Drop down	£585	£685	£765
Fixed	£545	£610	£710
<b>Tray Storage</b>			
Fixed	£545		

For full product specification see Victor product brochure or visit [www.victoronline.co.uk](http://www.victoronline.co.uk)

email: [sales@victormfg.co.uk](mailto:sales@victormfg.co.uk)

tel: 01274 722125

## Buffet/Carvery hot cupboard

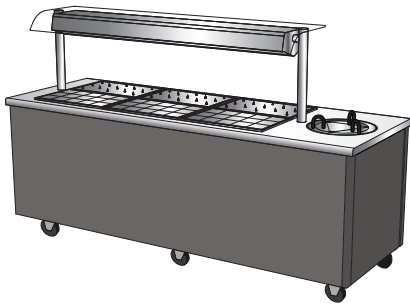

Features a heated plate dispenser, hot cupboard, and wet or dry heat Bain Marie well accommodating two rows of GN1/1 gastronorm containers or equivalent. Compatible with carvery pads, tiled inserts, or gastronorm containers to create a flexible carvery or self-service buffet solution. Available in left-hand (L) and right-hand (R) models, identified by the position of the plate dispenser when viewed from the chef's side. Price includes a curved glass quartz heated gantry with two rows of heat lamps directed to the front and rear of the countertop.

1740 x 800 x 900mm                      2330 x 800 x 900mm

base unit

<b>CARIBDBM12</b>	<b>£7,845</b>	<b>CARIBDBM19</b>	<b>£9,475</b>
5.95kW	4 pan	7.35kW	6 pan

Optional Extras		Drop down tray slide		TS17D	add £750	TS23D	add £985	
<b>DHTP1</b>	GN1/1 Tiled insert .....				<b>£355</b>	<b>57-0080</b>	Swivel arm feed valve .....	<b>£320</b>
<b>DHCP1</b>	GN1/1 Glass insert .....				<b>£325</b>	<b>57-0145</b>	Swivel arm drain assembly .....	<b>£205</b>
<b>BMCV1</b>	GN1/1 Carvery insert/Gravy dish for BM.....				<b>£300</b>	<b>COMMANDO</b>	Commando plug & cable .....	<b>£205</b>
<b>BMCV2</b>	GN1/1 Carvery insert for Bains Marie .....				<b>£250</b>			
<b>FP00006</b>	GN1/1 Stainless steel filler plate .....				<b>£90</b>			
<b>LOCK</b>	Lock to doors (per pair).....				<b>£190</b>			
							1205mm 1605mm 1905mm	
							Bridging bars	<b>£45    £60    £75</b>
							Additional shelf, bars & brackets	<b>£55    £80    £90</b>

## Caribbean - Refrigerated modules

### Blown air wells

Refrigerated well base unit with choice of gantry styles. 1606 & 1906mm units have open ambient cupboards to rear. All units under 3.1kW and supplied with cable and 13 amp plug. Refrigerated wells accept gastronorm containers up to 100mm deep. Units are 700mm deep and 900mm high to the counter top.

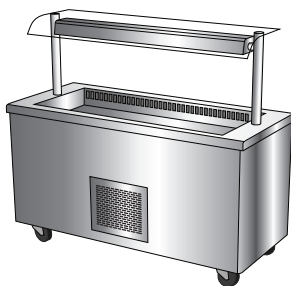

No Gantry		
<b>CARIB72.412</b>	1206mm	<b>£8,140</b>
		1.6kW
<b>CARIB72.416</b>	1606mm	<b>£9,595</b>
		2.1kW
<b>CARIB72.419</b>	1906mm	<b>£10,335</b>
		2.4kW

Collar for refrigerated well		
<b>COL016</b>	GN2/1 size	<b>£185</b>
<b>COL017</b>	GN3/1 size	<b>£205</b>

**Curved glass sneeze screen**

<b>CARIB72.412SY</b>	1206mm	<b>£9,585</b>
<b>CARIB72.416SY</b>	1606mm	<b>£11,120</b>
<b>CARIB72.419SY</b>	1906mm	<b>£11,965</b>

**Curved glass full screen**

<b>CARIB72.412DL</b>	1206mm	<b>£10,500</b>
<b>CARIB72.416DL</b>	1606mm	<b>£12,050</b>

**Caribbean round tube**

<b>CARIB72.412CC</b>	1206mm	<b>£9,445</b>
<b>CARIB72.416CC</b>	1606mm	<b>£10,920</b>
<b>CARIB72.419CC</b>	1906mm	<b>£11,710</b>

**Flat glass sneeze screen**

<b>CARIB72.412SS</b>	1206mm	<b>£9,585</b>
<b>CARIB72.416SS</b>	1606mm	<b>£11,120</b>
<b>CARIB72.419SS</b>	1906mm	<b>£11,965</b>

**Flat glass full screen**

<b>CARIB72.412SF</b>	1206mm	<b>£10,500</b>
<b>CARIB72.416SF</b>	1606mm	<b>£12,050</b>
<b>CARIB72.419SF</b>	1906mm	<b>£13,015</b>

**Curved glass full screen high**

<b>CARIB72.412HD</b>	1206mm	<b>£10,770</b>
<b>CARIB72.416HD</b>	1606mm	<b>£12,340</b>

### Blown air island wells

**Island flat glass**

<b>CARIB72.212IF</b>	1206mm	<b>£10,055</b>
<b>CARIB72.216IF</b>	1606mm	<b>£11,580</b>
<b>CARIB72.219IF</b>	1906mm	<b>£12,420</b>

**Caribbean Island**

<b>CARIB72.212DB</b>	1206mm	<b>£9,490</b>
<b>CARIB72.216DB</b>	1606mm	<b>£10,985</b>
<b>CARIB72.219DB</b>	1906mm	<b>£11,750</b>

**Island curved glass**

<b>CARIB72.212IS</b>	1206mm	<b>£10,055</b>
<b>CARIB72.216IS</b>	1606mm	<b>£11,580</b>

### Extras

Drop down tray slide	<b>CARIB16.412D</b>	add <b>£525</b>	<b>CARIB16.416D</b>	add <b>£740</b>	<b>CARIB16.419D</b>	add <b>£750</b>
Kick pinth	<b>KP12</b>	add <b>£260</b>	<b>KP16</b>	add <b>£290</b>	<b>KP19</b>	add <b>£300</b>

For full product specification see Victor product brochure or visit [www.victoronline.co.uk](http://www.victoronline.co.uk)

email: [sales@victormfg.co.uk](mailto:sales@victormfg.co.uk)

tel: 01274 722125

## Caribbean - Refrigerated modules

Blown air deck / deli

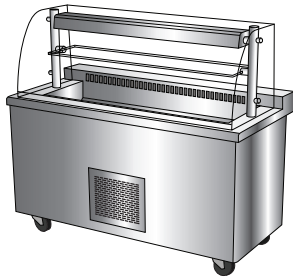

**Curved glass sneeze screen**

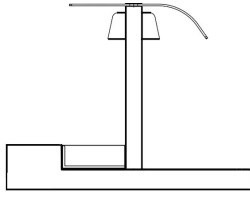

<b>CARIB72.912SY</b>	1206mm	<b>£9,875</b>
<b>CARIB72.916SY</b>	1606mm	<b>£11,455</b>
<b>CARIB72.919SY</b>	1906mm	<b>£12,335</b>

**Curved glass full screen**

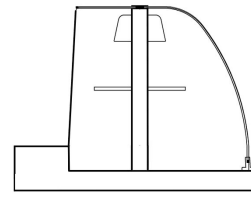

<b>CARIB72.912DL</b>	1206mm	<b>£10,815</b>
<b>CARIB72.916DL</b>	1606mm	<b>£12,435</b>

**Flat glass sneeze screen**

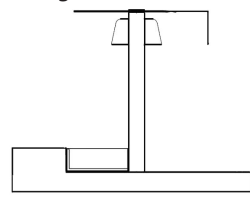

<b>CARIB72.912SS</b>	1206mm	<b>£9,875</b>
<b>CARIB72.916SS</b>	1606mm	<b>£11,455</b>
<b>CARIB72.919SS</b>	1906mm	<b>£12,335</b>

**Flat glass full screen**

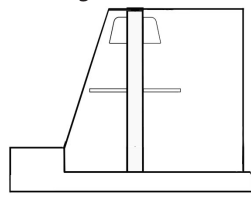

<b>CARIB72.912SF</b>	1206mm	<b>£10,815</b>
<b>CARIB72.916SF</b>	1606mm	<b>£12,435</b>
<b>CARIB72.919SF</b>	1606mm	<b>£13,495</b>

**Curved glass full screen high**

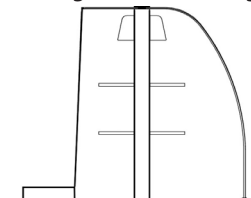

<b>CARIB72.912HD</b>	1206mm	<b>£11,080</b>
<b>CARIB72.916HD</b>	1606mm	<b>£12,740</b>

### Extras

<i>Drop down tray slide</i>	<b>CARIB16.412D</b> add <b>£525</b>	<b>CARIB16.416D</b> add <b>£740</b>	<b>CARIB16.419D</b> add <b>£750</b>
<i>Kick pinth</i>	<b>KP12</b> add <b>£260</b>	<b>KP16</b> add <b>£290</b>	<b>KP19</b> add <b>£300</b>
<i>Chopping board</i>	<b>72-0231</b> 600 x 250 x 40mm <b>£220</b>		

Victor Caribbean blown air refrigerated wells and deck are designed to meet the EN ISO 23953 standard and provide M1 Cabinet Class conditions (nominally 3°C core product temperature) exceeding the Climate Class 3 environment of 25°C in 60% RH. In use these units will maintain the product core temperature of pre chilled food below 5°C in ambient temperatures up to 27°C - 50% relative humidity. All units have self evaporating condense systems.

### Multi-tier - open fronted display

Refrigerated display - Meets EN ISO 23953 standard, providing M1 cabinet class conditions in climate class 3 of 25°C at 60% RH. Options of two or three shelf models, counter versions with rear opening doors or solid back wall models.

Caribbean

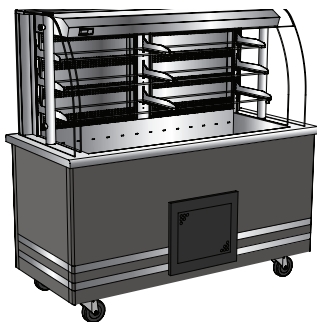

#### Three tier models

	1206 x 700 x 1600mm	1606 x 700 x 1600mm	1906 x 700 x 1600mm
Doors to rear			
<b>CARIB73.712</b>	<b>£11,955</b>	<b>CARIB73.716</b> <b>£13,410</b>	<b>CARIB73.719</b> <b>£15,160</b>
2.6kW		3.0kW	3.4kW
Solid back			
<b>CARIB73.712W</b>	<b>£11,955</b>	<b>CARIB73.716W</b> <b>£13,410</b>	<b>CARIB73.719W</b> <b>£15,160</b>
2.6kW		3.0kW	3.4kW

#### Two tier models

	1206 x 700 x 1430mm	1606 x 700 x 1430mm	1906 x 700 x 1430mm
Doors to rear			
<b>CARIB72.712</b>	<b>£11,615</b>	<b>CARIB72.716</b> <b>£13,410</b>	<b>CARIB72.719</b> <b>£14,945</b>
2.6kW		3.0kW	3.4kW
Solid back			
<b>CARIB72.712W</b>	<b>£11,615</b>	<b>CARIB72.716W</b> <b>£13,410</b>	<b>CARIB72.719W</b> <b>£14,945</b>
2.6kW		3.0kW	3.4kW

<i>Drop down tray slide</i>	<b>CARIB16.412D</b> add <b>£525</b>	<b>CARIB16.416D</b> add <b>£740</b>	<b>CARIB16.419D</b> add <b>£750</b>
<i>Night blind</i>	<b>NBC002</b> add <b>£430</b>	<b>NBC003</b> add <b>£550</b>	<b>NBC004</b> add <b>£690</b>

For full product specification see Victor product brochure or visit [www.victoronline.co.uk](http://www.victoronline.co.uk)

email: [sales@victormfg.co.uk](mailto:sales@victormfg.co.uk)

tel: 01274 722125

## Caribbean - Ancillary modules

### Ambient unit

Double skin construction, one wire shelf, open to rear.

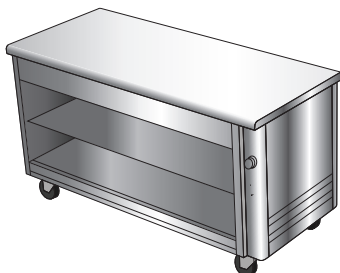

1206 x 700 x 900mm		1606 x 700 x 900mm		1906 x 700 x 900mm	
<b>CARIB10.12</b>	<b>£2,260</b>	<b>CARIB10.16</b>	<b>£2,455</b>	<b>CARIB10.19</b>	<b>£2,640</b>
Sliding doors to rear					
<b>DOORS12</b>	<b>£435</b>	<b>DOORS16</b>	<b>£540</b>	<b>DOORS19</b>	<b>£555</b>
<i>Drop down tray slide</i> <b>CARIB16.412D</b> add <b>£525</b>		<b>CARIB16.416D</b> add <b>£740</b>		<b>CARIB16.419D</b> add <b>£750</b>	

### Plate dispensers

Accepts plates 210mm - 285mm (8¼" - 11¼") approx 60 plates per tube. Larger plate sizes to special order.

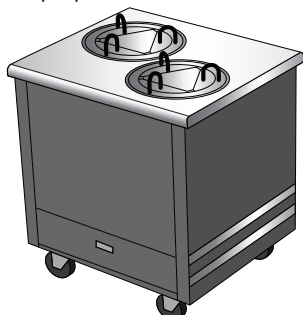

436 x 700 x 900mm		806 x 700 x 900mm	
unheated single		unheated double	
<b>CARIB12.4</b>	<b>£1,910</b>	<b>CARIB12.2</b>	<b>£2,755</b>
heated single		heated double	
<b>CARIB12.3</b>	<b>£2,145</b>	<b>CARIB12.1</b>	<b>£3,125</b>
0.8kW	with lid	0.8kW	with lids
<i>Drop down tray slide</i>		<b>CARIB16.408D</b> add <b>£525</b>	

### Cashier unit

Left or right handed models - complete with electric socket.

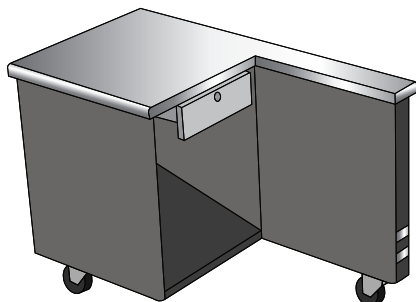

Part No	Dimensions	Loading	Price
<b>CARIB11L</b> (left)	1260 x 700 900	13 amp	<b>£1,810</b>
<b>CARIB11R</b> (right)	1260 x 700 900	13 amp	<b>£1,810</b>
<b>Extras</b>			
<b>CARIB16.412D</b>	Drop down trayslide		<b>£525</b>
<b>DRAWER</b>	Drawer		<b>£435</b>

### Soup station

With open ambient cupboard to rear. Left or right handed models - complete with electric socket.

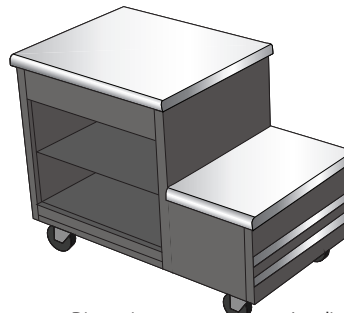

Part No	Dimensions	Loading	Price
<b>CARIB6AL</b> (left)	1260 x 700 900	13 amp	<b>£2,550</b>
<b>CARIB6AR</b> (right)	1260 x 700 900	13 amp	<b>£2,550</b>
<b>Extras</b>			
<b>CARIB16.412D</b>	Drop down trayslide		<b>£525</b>

For full product specification see Victor product brochure or visit [www.victoronline.co.uk](http://www.victoronline.co.uk)

email: [sales@victormfg.co.uk](mailto:sales@victormfg.co.uk)

tel: 01274 722125

**Caribbean - Ancillary modules**
**Tray trolley**

Accommodates approximately 250 trays.

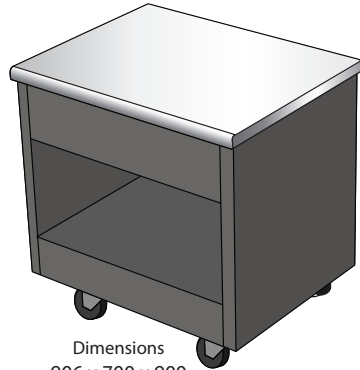

Part No	Dimensions	Price
<b>CARIB13</b>	906 x 700 x 900	<b>£1,530</b>
<b>Extras</b>		
<b>CARIB16.408D</b>	Drop down trayslide	<b>£525</b>

**Cutlery/tray trolley**

Accommodates 8 x GN1/4-150 and 3 x GN1/9-100 gastronorm containers (not included).

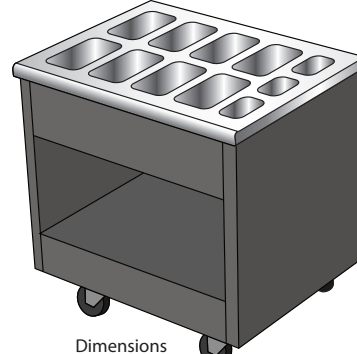

Part No	Dimensions	Price
<b>CARIB14A</b>	906 x 700 x 900	<b>£1,690</b>
<b>Extras</b>		
<b>CARIB16.408D</b>	Drop down trayslide	<b>£525</b>
<b>CONS14A</b>	Containers to suit	<b>£300</b>

**Cutlery/tray station**

With suspended rack accommodates 6 x GN1/4-150 and 3 x GN1/9-100 gastronorm containers (not included).

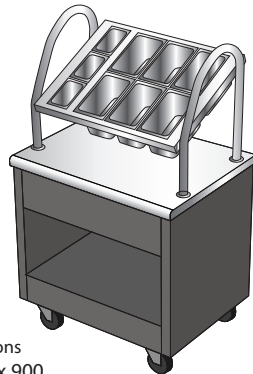

Part No	Dimensions	Price
<b>CARIB14B</b>	906 x 700 x 900	<b>£2,330</b>
<b>Extras</b>		
<b>CARIB16.408D</b>	Drop down trayslide	<b>£525</b>
<b>CONS14B</b>	Containers to suit	<b>£245</b>

**Square corner modules**

External fully enclosed or internal with open shelving.

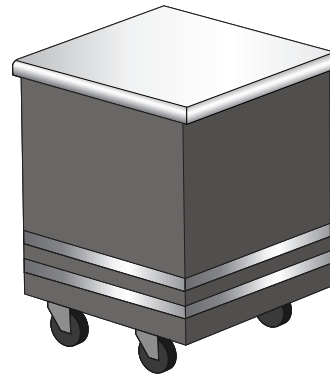

Part No	Dimensions	Price
<b>CARIB15.12e</b>	700 x 700 x 900	<b>£1,445</b>
<b>CARIB15.12i</b>	700 x 700 x 900	<b>£1,560</b>

**Hexagonal corner module - Internal**

Internal unit with open shelving to operator side.

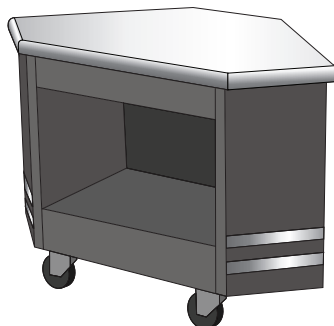

Part No	Dimensions	Price
<b>CARIB15.10i</b>	840mm across rear x 900mm high	<b>£1,780</b>
<i>Other sizes available - please contact our contracts department</i>		

**Hexagonal corner modules - External**

External unit deco panels to 5 sides - Stainless steel to operator side.

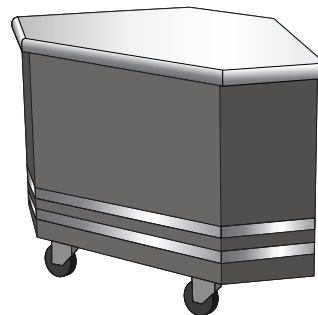

Part No	Dimensions	Price
<b>CARIB15.10e</b>	840mm across front x 900mm high	<b>£1,660</b>
<i>Other sizes available - please contact our contracts department</i>		

Caribbean

**For full product specification see Victor product brochure or visit [www.victoronline.co.uk](http://www.victoronline.co.uk)**

 email: [sales@victormfg.co.uk](mailto:sales@victormfg.co.uk)

tel: 01274 722125

**Jamaican food service system**

Available in coloured plastic coated steel or stainless steel finish, either mobile on castors or static on height adjustable feet. Stainless steel tops with square edge to front and rear edge, Hot cupboards complete with top hung sliding doors and two wire shelves. Units can be fitted with various gantry sneeze screen options - see page 28.

The Jamaican range of units can be manufactured to a working height of 800, 825, 850, 875 & 900mm with the overall height of the gantry approx. 1400mm. Please note blown air wells and multi-tier refrigerated units are only available 900mm high.

**Heated units - All units operate from a single 13 amp supply**

**Bains Marie hot cupboard** - Dry heat Bains Marie (containers not included), natural convection hot cupboard with 2 shelves.



880 x 670 x 900mm		1205 x 670 x 900mm		1535 x 670 x 900mm		1860 x 670 x 900mm	
<b>JBM20</b>	<b>£2,565</b>	<b>JBM30</b>	<b>£2,835</b>	<b>JBM40</b>	<b>£3,570</b>	<b>JBM50</b>	<b>£3,895</b>
1.9kW	2 pan	2.85kW	3 pan	2.4kW	4 pan	3.0kW	5 pan

**Plain top hot cupboard** - Stainless steel top, natural convection hot cupboard with two shelves.

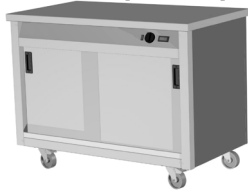

880 x 670 x 900mm		1205 x 670 x 900mm		1535 x 670 x 900mm		1860 x 670 x 900mm	
<b>JHC20</b>	<b>£2,140</b>	<b>JHC30</b>	<b>£2,455</b>	<b>JHC40</b>	<b>£3,090</b>	<b>JHC50</b>	<b>£3,435</b>
0.9kW		1.5kW		1.2kW		1.5kW	

**Glass top hot cupboard** - Heated glass top, natural convection hot cupboard with two shelves.

For effective food holding glass top units should be fitted with a quartz heated gantry

880 x 670 x 900mm		1205 x 670 x 900mm		1535 x 670 x 900mm	
<b>JGT20</b>	<b>£2,940</b>	<b>JGT30</b>	<b>£3,280</b>	<b>JGT40</b>	<b>£4,075</b>
1.9kW		2.1kW		2.4kW	



**Standard gantry option** - Other gantrys are available, see page 28.

**Heated curved glass** **GANCG20Q** £1,005 **GANCG30Q** £1,085 **GANCG40Q** £1,155 **GANCG50Q** £1,310  
0.6kW 0.9kW 0.64kW 0.8kW

**Standard trayslide option** - Drop-down (can be made fixed by use of locking bolt supplied) other traysides are available, see page 29.

**TS20** £290 **TS30** £325 **TS40** £385 **TS50** £435

**Stainless steel interior** - additional cost

**STSTINT20** £155 **STSTINT30** £195 **STSTINT40** £220 **STSTINT50** £250

**Additional shelf, bar & brackets** - For heated and ambients units

**SHELF20** £55 **SHELF30** £55 **SHELF40** £80 **SHELF50** £90

**Refrigerated wells - Counter models** JBA40 & 50 only available as 900mm high, JBA30 available at 850, 875 & 900mm high.

Stainless steel well with open ambient cupboard to rear. Not on JBA30 blown air models.



**Eutectic well**  
Eutectic plates

	1205 x 670 x 900mm		1535 x 670 x 900mm		1860 x 670 x 900mm	
<b>JEC30</b>	<b>£2,680</b>	<b>JEC40</b>	<b>£3,020</b>	<b>JEC50</b>	<b>£3,380</b>	
<b>70-0100</b> (3 x £175)	<b>£525</b>	<b>70-0100</b> (4 x £175)	<b>£700</b>	<b>70-0100</b> (5 x £175)	<b>£875</b>	
<b>Contact cooled well</b>	<b>JCC30</b>	<b>£5,315</b>	<b>JCC40</b>	<b>£6,290</b>	<b>JCC50</b>	<b>£6,505</b>
	1.5kW		1.5kW		1.5kW	
<b>Blown air well</b>	<b>JBA30</b>	<b>£6,735</b>	<b>JBA40</b>	<b>£8,200</b>	<b>JBA50</b>	<b>£9,105</b>
	1.6kW		2.1kW		2.4kW	

**Standard gantry option** - other gantrys are available, see page 28

**Curved glass LED illumination** **GANCG30L** £1,030 **GANCG40L** £1,185 **GANCG50L** £1,340

**Standard trayslide option** - Drop-down (can be made fixed by use of locking bolt supplied) other traysides are available, see page 29.

**TS30** £325 **TS40** £385 **TS50** £435

**Refrigerated wells - Island models** JBAI40 & 50 only available as 900mm high, JBAI30 available at 850, 875 & 900mm high.

Stainless steel well, panelled to all four sides.



**Eutectic well**  
Eutectic plates

	1205 x 670 x 900mm		1535 x 670 x 900mm		1860 x 670 x 900mm	
<b>JECI30</b>	<b>£2,680</b>	<b>JECI40</b>	<b>£3,020</b>	<b>JECI50</b>	<b>£3,380</b>	
<b>70-0100</b> (3 x £175)	<b>£525</b>	<b>70-0100</b> (4 x £175)	<b>£700</b>	<b>70-0100</b> (5 x £175)	<b>£875</b>	
<b>Contact cooled well</b>	<b>JCCI30</b>	<b>£5,315</b>	<b>JCCI40</b>	<b>£6,290</b>	<b>JCCI50</b>	<b>£6,505</b>
	1.5kW		1.5kW		1.5kW	
<b>Blown air well</b>	<b>JBAI30</b>	<b>£6,735</b>	<b>JBAI40</b>	<b>£8,200</b>	<b>JBAI50</b>	<b>£9,105</b>
	1.6kW		2.1kW		2.4kW	

**Standard gantry option** - other gantrys are available, see page 28.

Curved glass island **GANIS30L** £1,100 **GANIS40L** £1,355 N/A  
Flat glass island **GANFIS30L** £1,220 **GANFIS40L** £1,460 **GANFIS50L** £1,625

**Standard trayslide option** - Drop-down (can be made fixed by use of locking bolt supplied) other traysides are available, see page 29.

**TS30** (x 2) £650 **TS40** (x 2) £770 **TS50** (x 2) £870

**For full product specification see Victor product brochure or visit [www.victoronline.co.uk](http://www.victoronline.co.uk)**

email: [sales@victormfg.co.uk](mailto:sales@victormfg.co.uk)

tel: 01274 722125

## Jamaican gantry & over shelf options

The gantries below can be fitted to the unit shown on page 27 and the ambient units on page 30. When a quartz heated gantry is fixed to a heated unit the base unit electrical loadings are adjusted to ensure the units operates via the fitted **single 13 amp plug**.

**Curved glass sneeze screen (GANCG)**

Size	2 pan	3 pan	4 pan	5 pan
Quartz	£1,005	£1,085	£1,155	£1,310
kW	0.6	0.9	0.64	0.8
LED	£1,030	£1,030	£1,185	£1,340

**Flat glass sneeze screen (GANFGC)**

Size	2 pan	3 pan	4 pan	5 pan
Quartz	£1,020	£1,115	£1,220	£1,415
kW	0.6	0.9	0.64	0.8
LED	£1,045	£1,075	£1,255	£1,440

**Budget sneeze screen (GANSB)**

Size	2 pan	3 pan	4 pan	5 pan
Quartz	£775	£775	£865	£1,015
kW	0.6	0.9	0.64	0.8
LED	£775	£775	£865	£1,015

**Curved glass island screen (GANIS)**

Size	2 pan	3 pan	4 pan	5 pan
Quartz	n/a	£1,150	£1,315	n/a
kW		0.9	0.64	
LED	n/a	£1,100	£1,355	n/a

**Flat glass island screen (GANFIS)**

Size	2 pan	3 pan	4 pan	5 pan
Quartz	£1,110	£1,275	£1,430	£1,600
kW	0.6	0.9	0.64	0.8
LED	£1,145	£1,220	£1,460	£1,625

**Flat glass enclosed screen (GANFGF)**

Size	2 pan	3 pan	4 pan	5 pan
Quartz	£1,320	£1,405	£1,530	£1,735
kW	0.6	0.9	0.64	0.8
LED	£1,360	£1,360	£1,565	£1,770

**Kitchen servery style (GANKS)**

Size	2 pan	3 pan	4 pan	5 pan
Quartz	£1,005	£1,085	£1,155	£1,310
kW	0.6	0.9	0.64	0.8
LED	£1,005	£1,085	£1,155	£1,310

**Glass over shelf (GANOS)**

Size	2 pan	3 pan	4 pan	5 pan
Quartz	£315	£325	N/A	N/A

**Snack cart (GANS)**

Heated	GANSH130L	£2,385
Ambient	GANS30L no shelf	£1,430
	GANS130L 1 shelf	£1,585
	GANS230L 2 shelf	£1,730

Heated gantrys - Quartz	2 pan	3 pan	4 pan	5 pan
Curved glass sneeze screen	GANCG20Q £1,005	GANCG30Q £1,085	GANCG40Q £1,155	GANCG50Q £1,310
Flat glass sneeze screen	GANFGC20Q £1,020	GANFGC30Q £1,115	GANFGC40Q £1,220	GANFGC50Q £1,415
Curved glass island	N/A	GANIS30Q £1,150	GANIS40Q £1,315	N/A
Flat glass island	GANFIS20Q £1,110	GANFIS30Q £1,275	GANFIS40Q £1,430	GANFIS50Q £1,600
Flat glass enclosed screen	GANFGF20Q £1,320	GANFGF30Q £1,405	GANFGF40Q £1,530	GANFGF50Q £1,735
Budget sneeze screen	GANSB20Q £775	GANSB30Q £775	GANSB40Q £865	GANSB50Q £1,015
Kitchen servery style	GANKS20Q £1,005	GANKS30Q £1,085	GANKS40Q £1,155	GANKS50Q £1,310

Illuminated gantrys - LED	2 pan	3 pan	4 pan	5 pan
Curved glass sneeze screen	GANCG20L £1,030	GANCG30L £1,030	GANCG40L £1,185	GANCG50L £1,340
Flat glass sneeze screen	GANFGC20L £1,045	GANFGC30L £1,075	GANFGC40L £1,255	GANFGC50L £1,440
Curved glass island		GANIS30L £1,100	GANIS40L £1,355	
Flat glass island	GANFIS20L £1,145	GANFIS30L £1,220	GANFIS40L £1,460	GANFIS50L £1,625
Flat glass enclosed screen	GANFGF20L £1,360	GANFGF30L £1,360	GANFGF40L £1,565	GANFGF50L £1,770
Budget sneeze screen	GANSB20L £775	GANSB30L £775	GANSB40L £865	GANSB50L £1,015
Kitchen servery style	GANKS20L £1,005	GANKS30L £1,085	GANKS40L £1,155	GANKS50L £1,310
Glass over shelf <i>not illuminated</i>	GANOS20L £315	GANOS30L £325		

For full product specification see Victor product brochure or visit [www.victoronline.co.uk](http://www.victoronline.co.uk)

email: [sales@victormfg.co.uk](mailto:sales@victormfg.co.uk)

tel: 01274 722125

## Trayslide Options

All Jamaican tray slides are supplied as **drop-down** - they can be fixed in the upright position by use of locking bolts supplied.

### Three rail, 25mm tube

Standard	<b>TS20</b>	<b>£290</b>	<b>TS30</b>	<b>£325</b>	<b>TS40</b>	<b>£385</b>	<b>TS50</b>	<b>£435</b>
Curved ends	<b>TSC20</b>	<b>£455</b>	<b>TSC30</b>	<b>£495</b>	<b>TSC40</b>	<b>£535</b>	<b>TSC50</b>	<b>£605</b>
Fitted low level	<b>TSL20</b>	<b>£290</b>	<b>TSL30</b>	<b>£325</b>	<b>TSL40</b>	<b>£385</b>	<b>TSL50</b>	<b>£435</b>
Curved ends fitted low level	<b>TSLC20</b>	<b>£455</b>	<b>TSLC30</b>	<b>£495</b>	<b>TSLC40</b>	<b>£535</b>	<b>TSLC50</b>	<b>£605</b>

### Solid, Stainless Steel

Plain	<b>TSP20</b>	<b>£340</b>	<b>TSP30</b>	<b>£385</b>	<b>TSP40</b>	<b>£435</b>	<b>TSP50</b>	<b>£470</b>
Plain, fitted low level	<b>TSLP20</b>	<b>£340</b>	<b>TSLP30</b>	<b>£385</b>	<b>TSLP40</b>	<b>£435</b>	<b>TSLP50</b>	<b>£470</b>
Embossed	<b>TSS20</b>	<b>£340</b>	<b>TSS30</b>	<b>£385</b>	<b>TSS40</b>	<b>£435</b>	<b>TSS50</b>	<b>£470</b>
Embossed, fitted low level	<b>TSLS20</b>	<b>£340</b>	<b>TSLS30</b>	<b>£385</b>	<b>TSLS40</b>	<b>£435</b>	<b>TSLS50</b>	<b>£470</b>

### Three rail, 38mm tube

Standard	<b>TSA20</b>	<b>£340</b>	<b>TSA30</b>	<b>£385</b>	<b>TSA40</b>	<b>£435</b>	<b>TSA50</b>	<b>£470</b>
Curved ends	<b>TSAC20</b>	<b>£495</b>	<b>TSAC30</b>	<b>£545</b>	<b>TSAC40</b>	<b>£575</b>	<b>TSAC50</b>	<b>£675</b>

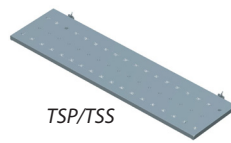

### Kick plinths - Slide on kick plinths finished in stainless or plastic coated steel.

3 sides	<b>KP20</b>	<b>£260</b>	<b>KP30</b>	<b>£260</b>	<b>KP40</b>	<b>£290</b>	<b>KP50</b>	<b>£300</b>
4 sides	<b>KPI20</b>	<b>£420</b>	<b>KPI30</b>	<b>£420</b>	<b>KPI40</b>	<b>£440</b>	<b>KPI50</b>	<b>£465</b>

## Insert Options

For use with JBM Bains Marie hot cupboard units. Converts Bains Marie into a heated, tiled, glass or carvery top.

<b>DHTP1</b>	GN1/1 Tiled insert .....	<b>£355</b>	<b>DHCP2</b>	GN2/1 Glass insert .....	<b>£600</b>
<b>DHTP2</b>	GN2/1 Tiled insert .....	<b>£710</b>	<b>DHCP3</b>	GN3/1 Glass insert .....	<b>£880</b>
<b>DHTP3</b>	GN3/1 Tiled insert .....	<b>£900</b>	<b>FP00006</b>	GN1/1 Stainless Steel Filler plate .....	<b>£90</b>
<b>DHTP5</b>	GN2/1 Tiled carvery insert with carvery pad ...	<b>£1,015</b>	<b>BRI008CS</b>	Bridging bars for BM per GN size .....	<b>£15</b>
<b>DHTP4</b>	GN3/1 Tiled carvery insert with carvery pad ...	<b>£1,220</b>	<b>Other Options</b>		
<b>AA-TI00</b>	Tiled insert for carvery pad space .....	<b>£325</b>	<b>P BAR</b>	Push bar .....	<b>£65</b>
<b>70-0300</b>	Spare carvery pad .....	<b>£295</b>	<b>TOPEX</b>	Drop down shelf to end .....	<b>£340</b>
<b>BMCV1</b>	GN1/1 Carvery Insert/Gravy Dish for BM .....	<b>£300</b>	<b>LOCK</b>	Lock to doors (per pair) .....	<b>£190</b>
<b>BMCV2</b>	GN1/1 Carvery Insert for Bains Marie .....	<b>£250</b>	<b>CORN-B</b>	Four corner bumpers .....	<b>£150</b>
<b>DHCP1</b>	GN1/1 Glass insert .....	<b>£325</b>	<b>COL016</b>	GN2/1 collar for refrigerated well .....	<b>£185</b>
			<b>COL017</b>	GN3/1 collar for refrigerated well .....	<b>£205</b>

## Ambient Unit

Stainless steel top, stainless steel interior, one wire shelf, open to rear to accommodate accessories below.

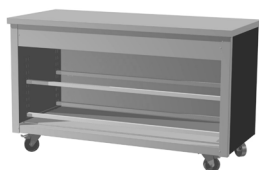

	880 x 670 x 900mm	1205 x 670 x 900mm	1535 x 670 x 900mm	1860 x 670 x 900mm
	<b>JAMB20</b>	<b>£1,490</b>	<b>JAMB30</b>	<b>£1,640</b>
	<b>JAMB40</b>	<b>£1,870</b>	<b>JAMB50</b>	<b>£2,030</b>
<b>Doors</b>				
<b>DOOR20</b>	<b>£340</b>	<b>DOOR30</b>	<b>£340</b>	<b>DOOR40</b>
			<b>£355</b>	<b>DOOR50</b>
				<b>£370</b>
<b>Additional shelf, bar &amp; brackets</b>				
<b>SHELF20</b>	<b>£55</b>	<b>SHELF30</b>	<b>£55</b>	<b>SHELF40</b>
			<b>£80</b>	<b>SHELF50</b>
				<b>£90</b>
<b>Electrical socket switched</b> - Double positioned central to operator side.				<b>£190</b>

## Refrigerated multi-tier display

Refrigerated multi-tier with stainless steel well, 3 glass shelves, and LED illumination to top. Meets EN ISO 23953 standard, providing M2 cabinet class conditions in climate class 3 of 25°C at 60% RH. Options of two or three shelf models, counter versions with rear opening doors or solid back wall models. **Only available at 900mm high.**

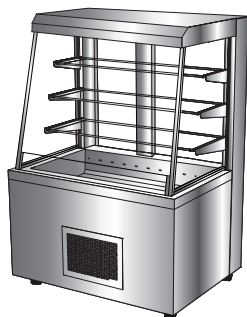

	1015 x 670 x 1680mm	1315 x 670 x 1680mm
<b>Counter models</b> - with rear loading doors controls to rear		
<b>JMT10</b>	<b>£9,455</b>	<b>JMT13</b>
		<b>£10,200</b>
	2.5kW	2.7kW
	1015 x 820 x 1680mm	1315 x 820 x 1680mm
<b>Wall models</b> - solid back controls to front		
<b>JMTW10</b>	<b>£9,370</b>	<b>JMTW13</b>
		<b>£10,110</b>
	2.5kW	2.7kW
<b>Tray slide</b>	<b>TS10</b>	<b>£290</b>
		<b>TS13</b>
		<b>£325</b>
<b>Night Blind</b>	<b>NBJMT10</b>	<b>£465</b>
		<b>NBJMT13</b>
		<b>£535</b>

For full product specification see Victor product brochure or visit [www.victoronline.co.uk](http://www.victoronline.co.uk)

email: [sales@victormfg.co.uk](mailto:sales@victormfg.co.uk)

tel: 01274 722125

**Ancillary units**
**Tray trolley**

Accommodates approximately 250 trays.

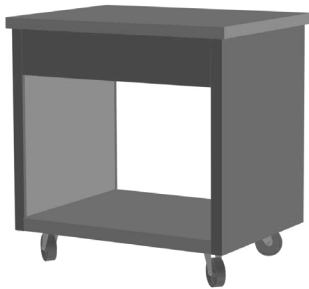

Part No	Dimensions	Price
<b>JTT</b>	880 x 670 x 900	<b>£1,220</b>
<b>Extras</b>		
<b>TS20</b>	Drop down tray slide	<b>£290</b>

**Cutlery/tray trolley**

Accepts 6 x GN1/4-150 and 3 x GN1/9-100 gastronorm containers (not included).

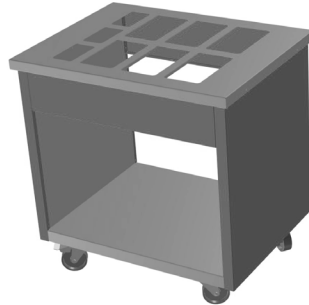

Part No	Dimensions	Price
<b>JCT</b>	880 x 670 x 900	<b>£1,290</b>
<b>Extras</b>		
<b>TS20</b>	Drop down tray slide	<b>£290</b>
<b>CONSJCT</b>	Containers to suit	<b>£245</b>

**Cutlery/tray station**

With suspended rack accommodates 6 x GN1/4-150 and 3 x GN1/9-100 gastronorm containers (not included).

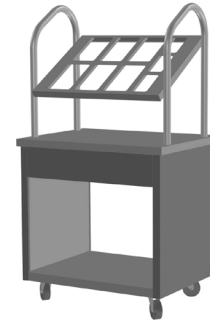

Part No	Dimensions	Price
<b>JCTC</b>	880 x 670 x 900	<b>£2,210</b>
<b>Extras</b>		
<b>TS20</b>	Drop down tray slide	<b>£290</b>
<b>CONSJCT</b>	Containers to suit	<b>£245</b>

**Hexagonal corner module - Internal**

Internal unit with open shelving to operator side.



Part No	Dimensions	Price
<b>JHI</b>	1000mm to parallel ends x 900mm high	<b>£1,530</b>

**Clearing trolley**

Complete with 3 x plastic bins

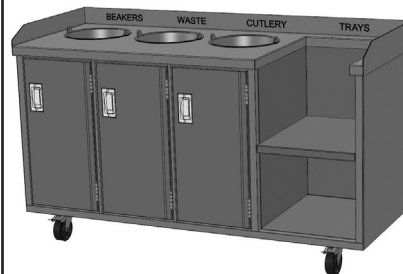

Part No	Dimensions	Price
<b>JCLT</b>	1535 x 600 x 850 <i>Only available 850mm high</i>	<b>£2,165</b>
<b>Extras</b>		
<b>53-0370</b>	Additional Bins	<b>£15 each</b>

**Hexagonal corner modules - External**

Deco panels to 5 sides - Stainless steel to operator side.

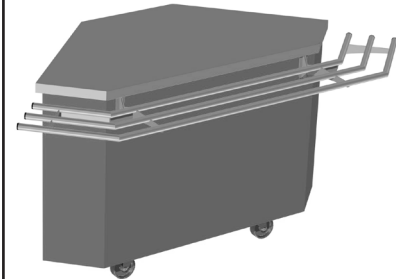

Part No	Dimensions	Price
<b>JHO</b>	1000mm to parallel ends x 900mm high	<b>£1,450</b>
<b>TSHEX</b>	Drop down tray slide	<b>£665</b>

**Cashier unit**

Left or right handed models - complete with electric socket.

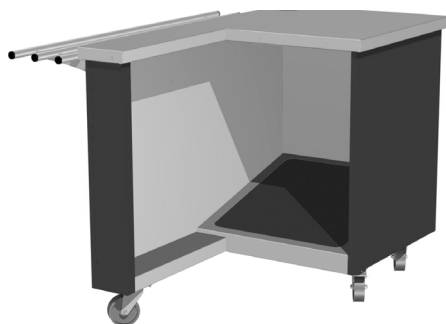

Part No	Dimensions	Loading	Price
<b>JCL30</b> (left)	1205 x 670 x 900	13 amp	<b>£1,765</b>
<b>JCR30</b> (right)	1205 x 670 x 900	13 amp	<b>£1,765</b>
<b>Extras</b>			
<b>TS30</b>	Drop down trayslide		<b>£325</b>
<b>DRAWER</b>	Drawer		<b>£435</b>

**Plate Dispensers**

Spring loaded mechanism. Accepts 210mm-285mm plates approx 60 per tube.

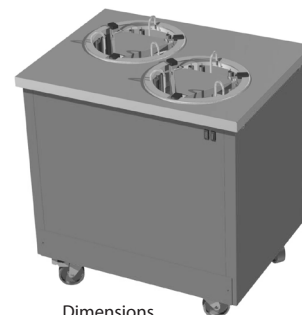

*Plate dispensers are only available 900mm high*

Part No	Dimensions	Price
Single tube		
<b>JPDAS</b>	455 x 670 x 900 unheated	<b>£1,730</b>
<b>JPDHS</b>	455 x 670 x 900 heated 0.8kW	<b>£2,080</b>
Double tube		
<b>JPDAD</b>	880 x 670 x 900 unheated	<b>£2,650</b>
<b>JPDHD</b>	880 x 670 x 900 heated 0.8kW	<b>£2,915</b>
<b>Extras</b>		
<b>TS20</b>	Drop down trayslide <i>Double unit only</i>	<b>£290</b>

**Heated units - Curved glass**

Designed to maintain the temperature of hot food by providing heat from below, supplemented by heat from above by 1 x 300 watt operator changeable quartz heat lamp per gastronorm size. Both top and lower heat levels are fully controllable. Controls are housed in the gantry hood. Glass screens are made from toughened glass.

**Heated Bains Marie - Dry heat 65mm deep well**

*Max 65mm deep containers allows for roll under Hot cupboard below.*

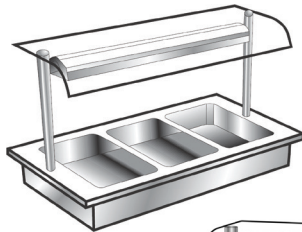

GN1/1 Capacity	Part Number	Top size (mm)	Power (kW)	Cut out (mm)	Price £
1	DHBM1	525 x 660 x 540	0.7	400 x 636	£2,425
2	DHBM2	850 x 660 x 540	1.5	725 x 636	£3,240
3	DHBM3	1177 x 660 x 540	2.4	1045 x 636	£3,475
4	DHBM4	1504 x 660 x 540	3.0	1370 x 636	£3,840
5	DHBM5	1831 x 660 x 540	3.9	1700 x 636	£3,960
6	DHBM6	2158 x 660 x 540	4.8	2025 x 636	£4,700

**For front mounted controls add C to end of Part Number**

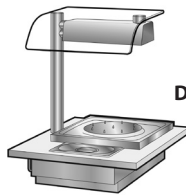

**Dedicated single carvery unit**

-Complete with removable spiked carvery pad and GN1/4 container for Gravy.

DHBC1	525 x 660 x 540	0.7	400 x 636	£2,680
-------	-----------------	-----	-----------	--------

**Heated Bains Marie - Dry heat 65mm deep well - enclosed**

*Max 65mm deep containers allows for roll under Hot cupboard below.*

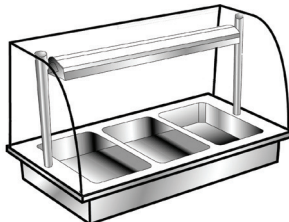

GN1/1 Capacity	Part Number	Top size (mm)	Power (kW)	Cut out (mm)	Price £
2	DHBM2E	850 x 660 x 540	1.5	725 x 636	£3,825
3	DHBM3E	1177 x 660 x 540	2.4	1045 x 636	£4,065
4	DHBM4E	1504 x 660 x 540	3.0	1370 x 636	£4,440

**Heated Bains Marie - Dry heat 150mm deep well**

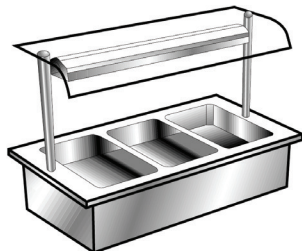

GN1/1 Capacity	Part Number	Top size (mm)	Power (kW)	Cut out (mm)	Price £
2	DHBD2	850 x 660 x 540	1.5	725 x 636	£3,240
3	DHBD3	1177 x 660 x 540	2.4	1045 x 636	£3,475
4	DHBD4	1504 x 660 x 540	3.0	1370 x 636	£3,840
5	DHBD5	1831 x 660 x 540	3.9	1700 x 636	£3,960
6	DHBD6	2158 x 660 x 540	4.8	2025 x 636	£4,700

**For front mounted controls add C to end of Part Number**

**Heated Bains Marie - Dry heat 150mm deep well - enclosed**

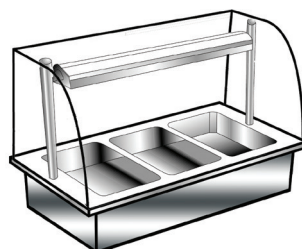

GN1/1 Capacity	Part Number	Top size (mm)	Power (kW)	Cut out (mm)	Price £
2	DHBD2E	850 x 660 x 540	1.5	725 x 636	£3,825
3	DHBD3E	1177 x 660 x 540	2.4	1045 x 636	£4,065
4	DHBD4E	1504 x 660 x 540	3.0	1370 x 636	£4,440

**Heated Bains Marie - Wet or dry heat 150mm deep well**

*Max 150mm deep containers. Drain-off tap at operator left hand side.*

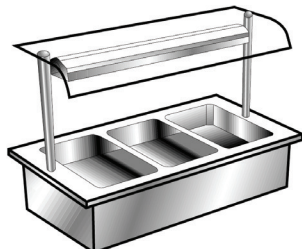

GN1/1 Capacity	Part Number	Top size (mm)	Power (kW)	Cut out (mm)	Price £
2	DHBW2	850 x 660 x 540	1.5	725 x 646	£3,395
3	DHBW3	1177 x 660 x 540	2.4	1045 x 646	£3,695
4	DHBW4	1504 x 660 x 540	3.0	1370 x 646	£4,075
5	DHBW5	1831 x 660 x 540	3.9	1700 x 646	£4,330

**For front mounted controls add C to end of Part Number**

**For full product specification see Victor product brochure or visit [www.victoronline.co.uk](http://www.victoronline.co.uk)**

email: [sales@victormfg.co.uk](mailto:sales@victormfg.co.uk)

tel: 01274 722125

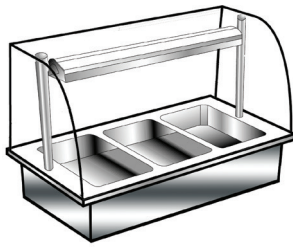
**Heated Bains Marie - Wet or dry heat 150mm deep well - enclosed**
*Max 150mm deep containers. Drain-off tap at operator left hand side.*

GN1/1 Capacity	Part Number	Top size (mm)	Power (kW)	Cut out (mm)	Price £
2	DHBW2E	850 x 660 x 540	1.5	725 x 646	£3,965
3	DHBW3E	1177 x 660 x 540	2.4	1045 x 646	£4,285
4	DHBW4E	1504 x 660 x 540	3.0	1370 x 646	£4,675

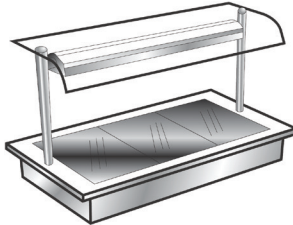
**Heated ceramic hot plate**

GN1/1 Capacity	Part Number	Top size (mm)	Power (kW)	Cut out (mm)	Price £
2	DHHP2	850 x 660 x 540	1.5	725 x 636	£3,475
3	DHHP3	1177 x 660 x 540	2.4	1045 x 636	£3,715
4	DHHP4	1504 x 660 x 540	3.0	1370 x 636	£3,960
5	DHHP5	1831 x 660 x 540	3.9	1700 x 636	£4,205
6	DHHP6	2158 x 660 x 540	4.8	2025 x 636	£4,810

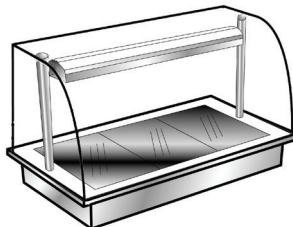
**For front mounted controls add C to end of Part Number**
**Heated ceramic hot plate - enclosed**

GN1/1 Capacity	Part Number	Top size (mm)	Power (kW)	Cut out (mm)	Price £
2	DHHP2E	850 x 660 x 540	1.5	725 x 636	£4,065
3	DHHP3E	1177 x 660 x 540	2.4	1045 x 636	£4,315
4	DHHP4E	1504 x 660 x 540	3.0	1370 x 636	£4,560

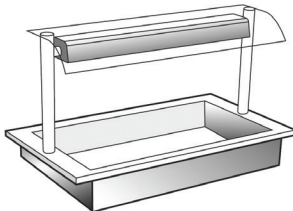
**Heated recessed top**

GN1/1 Capacity	Part Number	Top size (mm)	Power (kW)	Cut out (mm)	Price £
2	DHRT2	850 x 660 x 540	1.5	725 x 646	£3,395
3	DHRT3	1177 x 660 x 540	2.4	1045 x 646	£3,695
4	DHRT4	1504 x 660 x 540	3.0	1370 x 646	£4,075
5	DHRT5	1831 x 660 x 540	3.9	1700 x 646	£4,330

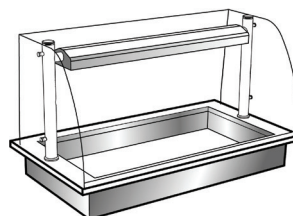
**For front mounted controls add C to end of Part Number**
**Heated recessed top - enclosed**

GN1/1 Capacity	Part Number	Top size (mm)	Power (kW)	Cut out (mm)	Price £
2	DHRT2E	850 x 660 x 540	1.5	725 x 646	£3,965
3	DHRT3E	1177 x 660 x 540	2.4	1045 x 646	£4,285
4	DHRT4E	1504 x 660 x 540	3.0	1370 x 646	£4,675

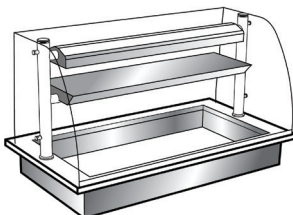
**Heated display deli**

GN1/1 Capacity	Part Number	Top size (mm)	Power (kW)	Cut out (mm)	Price £
2	DHDL2	850 x 660 x 540	1.4	725 x 646	£5,205
3	DHDL3	1177 x 660 x 540	2.1	1045 x 646	£5,755
4	DHDL4	1504 x 660 x 540	2.8	1370 x 646	£5,965

**Extras**

<b>BMCV1</b>	Carvery insert/gravy dish for BM GN1/1 size .....	£300
<b>BMCV2</b>	Carvery insert full size for BM GN1/1 size.....	£250
<b>DHCP1</b>	Ceramic insert GN1/1 size .....	£325
<b>DHTP1</b>	Tiled insert GN1/1 size .....	£355
<b>BMCV3</b>	Carvery insert & Cradle Collar for DHHP units .....	£260

*This collar is not suitable if drop-in is flush fitted in counter top.*
**Topper base**
*Allows heated Synergy drop-in to be used as a table top unit (Ceramic hotplates and 65mm deep Bains Maries only).*

<b>DHTB1</b>	Topper base heated GN1 size .....	£240
<b>DHTB2</b>	Topper base heated GN2 size .....	£260
<b>DHTB3</b>	Topper base heated GN3 size .....	£295
<b>DHTB4</b>	Topper base heated GN4 size .....	£325

**Refrigerated units - Curved glass**

Designed to meet the EN ISO 23953 standard and provide M1 Cabinet Class conditions exceeding the Climate Class 3 environment of 25°C in 60% RH. In use Victor refrigerated Synergy units will maintain the product core temperature of pre chilled food below 5°C in ambient temperatures up to 27°C - 50% relative humidity. Synergy units are illuminated using LED lamps. All controls are mounted on the unit. Removable fascia grills are provided for mounting on the counter front to allow air intake and to facilitate cleaning. All units have self evaporating condense systems.

**Refrigerated blown air deck**

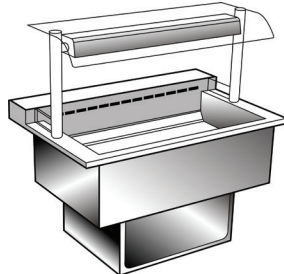

**Refrigerated units can be supplied without compressors for remote refrigeration at a reduction of £515 per unit**

GN1/1 Capacity	Part Number	Top size (mm)	Power (kW)	Cut out (mm)	Price £
2	DRDK2	850 x 755 x 540	1.6	725 x 646	£5,275
3	DRDK3	1177 x 755 x 540	1.6	1045 x 646	£5,660
4	DRDK4	1504 x 755 x 540	2.1	1370 x 646	£5,955
5	DRDK5	1831 x 755 x 540	2.4	1700 x 646	£6,555

**For front mounted controls add C to end of Part Number**

**Refrigerated blown air well**

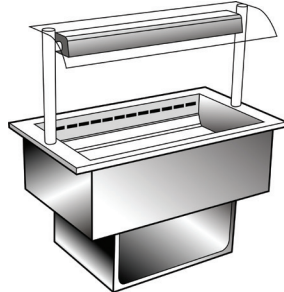

GN1/1 Capacity	Part Number	Top size (mm)	Power (kW)	Cut out (mm)	Price £
2	DRWL2	850 x 660 x 540	1.6	725 x 646	£5,120
3	DRWL3	1177 x 660 x 540	1.6	1045 x 646	£5,505
4	DRWL4	1504 x 660 x 540	2.1	1370 x 646	£5,790
5	DRWL5	1831 x 660 x 540	2.4	1700 x 646	£6,415

**For front mounted controls add C to end of Part Number**

**Refrigerated blown air well - enclosed**

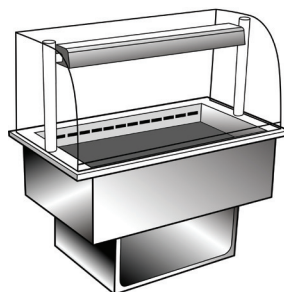

GN1/1 Capacity	Part Number	Top size (mm)	Power (kW)	Cut out (mm)	Price £
2	DRWL2E	850 x 660 x 540	1.6	725 x 646	£5,660
3	DRWL3E	1177 x 660 x 540	1.6	1045 x 646	£6,020
4	DRWL4E	1504 x 660 x 540	2.1	1370 x 646	£6,415

**Refrigerated island well**

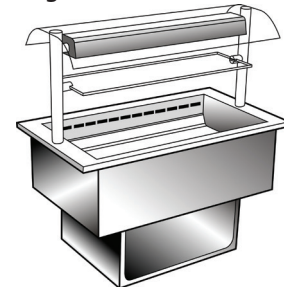

GN1/1 Capacity	Part Number	Top size (mm)	Power (kW)	Cut out (mm)	Price £
3	DRIW3	1177 x 660 x 540	1.6	1045 x 646	£5,790
4	DRIW4	1504 x 660 x 540	2.1	1370 x 646	£6,180

**Refrigerated display deli**

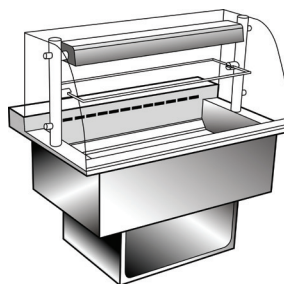

GN1/1 Capacity	Part Number	Top size (mm)	Power (kW)	Cut out (mm)	Price £
2	DRDL2	850 x 755 x 540	1.6	725 x 646	£5,955
3	DRDL3	1177 x 755 x 540	1.6	1045 x 646	£6,320
4	DRDL4	1504 x 755 x 540	2.1	1370 x 646	£6,710

*Victor Synergy units are supplied with an integral telescopic baffling and air duct system arrangement to facilitate various venting configurations. The majority can be achieved without pre-specifying, but if it is envisaged that a refrigerated unit will be installed without access to the front of the refrigeration housing, (e.g. behind a dwarf wall), please contact our sales department to ensure that the correct unit is supplied.*

Synergy

**For full product specification see Victor product brochure or visit [www.victoronline.co.uk](http://www.victoronline.co.uk)**

email: [sales@victormfg.co.uk](mailto:sales@victormfg.co.uk)

tel: 01274 722125

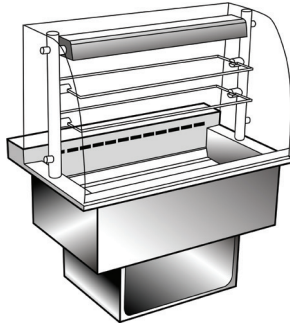
**Refrigerated high deli**

GN1/1 Capacity	Part Number	Top size (mm)	Power (kW)	Cut out (mm)	Price £
3	<b>DRDH3</b>	1177 x 755 x 710	1.6	1045 x 646	<b>£6,780</b>
4	<b>DRDH4</b>	1504 x 755 x 710	2.1	1370 x 646	<b>£7,230</b>

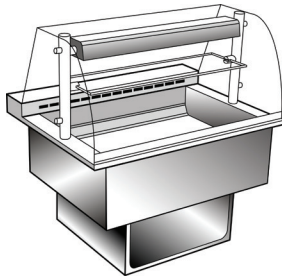
**Refrigerated deep deli**

GN1/1 Capacity	Part Number	Top size (mm)	Power (kW)	Cut out (mm)	Price £
2	<b>DRDD2</b>	850 x 905 x 540	1.6	725 x 796	<b>£6,180</b>
3	<b>DRDD3</b>	1177 x 905 x 540	1.6	1045 x 796	<b>£6,620</b>
4	<b>DRDD4</b>	1504 x 905 x 540	2.1	1370 x 796	<b>£7,070</b>

**Extras**

**72-0231** Polyethylene chopping board - 600 x 250 x 40mm **£220**

**Collar for refrigerated well**

**COL016** - GN2/1 size - **£185**      **COL017** - GN3/1 size - **£205**

**Glass mid shelf**

GN2/1 size - **£260**    GN3/1 size - **£260**    GN4/1 size - **£300**    GN5/1 size - **£340**

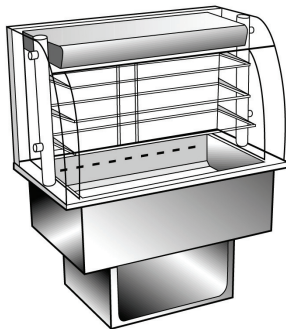
**Refrigerated three tier multi-deck**

**- doors to rear**

GN1/1 Capacity	Part Number	Top size (mm)	Power (kW)	Cut out (mm)	Price £
2	<b>DRMT2</b>	850 x 660 x 710	2.1	725 x 646	<b>£7,830</b>
3	<b>DRMT3</b>	1177 x 660 x 710	2.6	1045 x 646	<b>£8,280</b>
4	<b>DRMT4</b>	1504 x 660 x 710	3.0	1370 x 646	<b>£9,340</b>
5	<b>DRMT5</b>	1831 x 660 x 710	3.4*	1700 x 646	<b>£10,395</b>

**- solid back**

GN1/1 Capacity	Part Number	Top size (mm)	Power (kW)	Cut out (mm)	Price £
2	<b>DRMT2W</b>	850 x 660 x 710	2.1	725 x 646	<b>£7,390</b>
3	<b>DRMT3W</b>	1177 x 660 x 710	2.6	1045 x 646	<b>£7,830</b>
4	<b>DRMT4W</b>	1504 x 660 x 710	3.0	1370 x 646	<b>£8,885</b>
5	<b>DRMT5W</b>	1831 x 660 x 710	3.4*	1700 x 646	<b>£9,935</b>

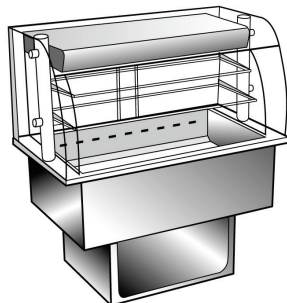
\*Five pan size units require a 16 amp supply. These units are very large, heavy and are more suitable for build around rather than drop-in.

**Refrigerated two tier multi-deck**

**- doors to rear**

GN1/1 Capacity	Part Number	Top size (mm)	Power (kW)	Cut out (mm)	Price £
2	<b>DRMT22</b>	850 x 660 x 540	2.1	725 x 646	<b>£7,375</b>
3	<b>DRMT23</b>	1177 x 660 x 540	2.6	1045 x 646	<b>£7,985</b>
4	<b>DRMT24</b>	1504 x 660 x 540	3.0	1370 x 646	<b>£9,035</b>
5	<b>DRMT25</b>	1831 x 660 x 540	3.4*	1700 x 646	<b>£10,085</b>

**- Solid back wall models**

GN1/1 Capacity	Part Number	Top size (mm)	Power (kW)	Cut out (mm)	Price £
2	<b>DRMT22W</b>	850 x 660 x 540	2.1	725 x 646	<b>£7,070</b>
3	<b>DRMT23W</b>	1177 x 660 x 540	2.6	1045 x 646	<b>£7,535</b>
4	<b>DRMT24W</b>	1504 x 660 x 540	3.0	1370 x 646	<b>£8,580</b>
5	<b>DRMT25W</b>	1831 x 660 x 540	3.4*	1700 x 646	<b>£9,645</b>

\*Five pan size units require a 16 amp supply. These units are very large, heavy and are more suitable for build around rather than drop-in.

**Heated units - Flat glass**

Designed to maintain the temperature of hot food by providing heat from below, supplemented by heat from above by 1 x 300 watt operator changeable quartz heat lamp per gastronorm size. Both top and lower heat levels are fully controllable. Controls are housed in the gantry hood. Glass screens are made from toughened glass.

**Heated Bains Marie - Dry heat 65mm deep well- allows for roll under Hot cupboard below.**

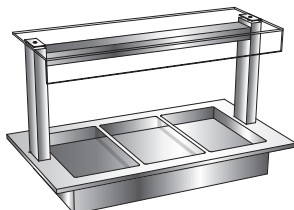

GN1/1 Capacity	Part Number	Top size (mm)	Power (kW)	Cut out (mm)	Price £
1	SSHBM1	525 x 660 x 540	0.7	400 x 636	£2,425
2	SSHBM2	850 x 660 x 540	1.5	725 x 636	£3,240
3	SSHBM3	1177 x 660 x 540	2.4	1045 x 636	£3,475
4	SSHBM4	1504 x 660 x 540	3.0	1370 x 636	£3,840
5	SSHBM5	1831 x 660 x 540	3.9	1700 x 636	£3,960
6	SSHBM6	2158 x 660 x 540	4.8	2025 x 636	£4,700

**For front mounted controls add C to end of Part Number**

**Heated Bains Marie - Dry heat 65mm deep well - enclosed - allows for roll under Hot cupboard below.**

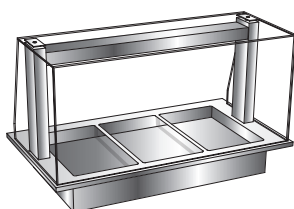

GN1/1 Capacity	Part Number	Top size (mm)	Power (kW)	Cut out (mm)	Price £
2	SFHBM2	850 x 660 x 540	1.5	725 x 636	£3,650
3	SFHBM3	1177 x 660 x 540	2.4	1045 x 636	£3,905
4	SFHBM4	1504 x 660 x 540	3.0	1370 x 636	£4,255
5	SFHBM5	1831 x 660 x 540	3.9	1700 x 636	£4,365
6	SFHBM6	2158 x 660 x 540	4.8	2025 x 636	£5,105

**Heated Bains Marie - Dry heat 150mm deep well**

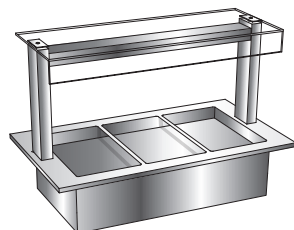

GN1/1 Capacity	Part Number	Top size (mm)	Power (kW)	Cut out (mm)	Price £
2	SSHBD2	850 x 660 x 540	1.5	725 x 636	£3,240
3	SSHBD3	1177 x 660 x 540	2.4	1045 x 636	£3,475
4	SSHBD4	1504 x 660 x 540	3.0	1370 x 636	£3,840
5	SSHBD5	1831 x 660 x 540	3.9	1700 x 636	£3,960
6	SSHBD6	2158 x 660 x 540	4.8	2025 x 636	£4,700

**For front mounted controls add C to end of Part Number.**

**Heated Bains Marie - Dry heat 150mm deep well - enclosed**

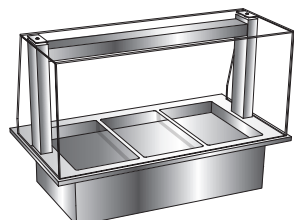

GN1/1 Capacity	Part Number	Top size (mm)	Power (kW)	Cut out (mm)	Price £
2	SFHBD2	850 x 660 x 540	1.5	725 x 636	£3,650
3	SFHBD3	1177 x 660 x 540	2.4	1045 x 636	£3,905
4	SFHBD4	1504 x 660 x 540	3.0	1370 x 636	£4,255
5	SFHBD5	1831 x 660 x 540	3.9	1700 x 636	£4,365
6	SFHBD6	2158 x 660 x 540	4.8	2025 x 636	£5,105

**Heated Bains Marie - Wet or dry heat 150mm deep well - Drain-off tap at operator left hand side.**

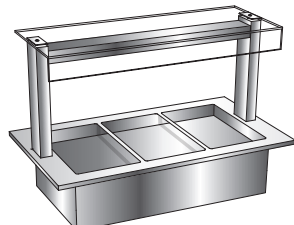

GN1/1 Capacity	Part Number	Top size (mm)	Power (kW)	Cut out (mm)	Price £
2	SSHBW2	850 x 660 x 540	1.5	725 x 646	£3,395
3	SSHBW3	1177 x 660 x 540	2.4	1045 x 646	£3,695
4	SSHBW4	1504 x 660 x 540	3.0	1370 x 646	£4,075
5	SSHBW5	1831 x 660 x 540	3.9	1700 x 646	£4,330

**For front mounted controls add C to end of Part Number**

**Heated Bains Marie - Wet or dry heat 150mm deep well - enclosed - Drain-off tap at operator left hand side.**

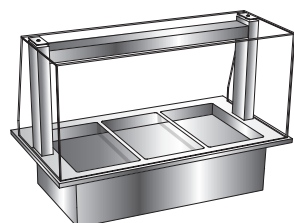

GN1/1 Capacity	Part Number	Top size (mm)	Power (kW)	Cut out (mm)	Price £
2	SFHBW2	850 x 660 x 540	1.5	725 x 646	£3,800
3	SFHBW3	1177 x 660 x 540	2.4	1045 x 646	£4,095
4	SFHBW4	1504 x 660 x 540	3.0	1370 x 646	£4,495
5	SFHBW5	1831 x 660 x 540	3.9	1700 x 646	£4,725

**For full product specification see Victor product brochure or visit [www.victoronline.co.uk](http://www.victoronline.co.uk)**

email: [sales@victormfg.co.uk](mailto:sales@victormfg.co.uk)

tel: 01274 722125

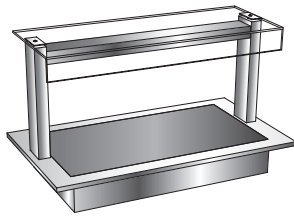
**Heated ceramic hot plate**

GN1/1 Capacity	Part Number	Top size (mm)	Power (kW)	Cut out (mm)	Price £
2	<b>SSHHP2</b>	850 x 660 x 540	1.5	725 x 636	<b>£3,475</b>
3	<b>SSHHP3</b>	1177 x 660 x 540	2.4	1045 x 636	<b>£3,715</b>
4	<b>SSHHP4</b>	1504 x 660 x 540	3.0	1370 x 636	<b>£3,960</b>
5	<b>SSHHP5</b>	1831 x 660 x 540	3.9	1700 x 636	<b>£4,205</b>
6	<b>SSHHP6</b>	2158 x 660 x 540	4.8	2025 x 636	<b>£4,810</b>

**For front mounted controls add C to end of Part Number**

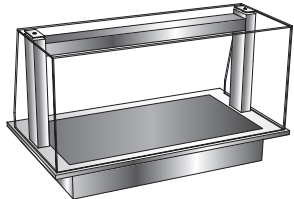
**Heated ceramic hot plate - enclosed**

GN1/1 Capacity	Part Number	Top size (mm)	Power (kW)	Cut out (mm)	Price £
2	<b>SFHHP2</b>	850 x 660 x 540	1.5	725 x 636	<b>£3,905</b>
3	<b>SFHHP3</b>	1177 x 660 x 540	2.4	1045 x 636	<b>£4,130</b>
4	<b>SFHHP4</b>	1504 x 660 x 540	3.0	1370 x 636	<b>£4,365</b>
5	<b>SFHHP5</b>	1831 x 660 x 540	3.9	1700 x 636	<b>£4,615</b>
6	<b>SFHHP6</b>	2158 x 660 x 540	4.8	2025 x 636	<b>£5,205</b>

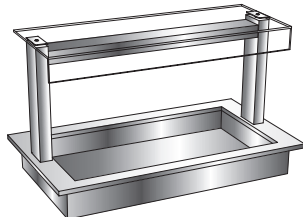
**Heated recessed top**

GN1/1 Capacity	Part Number	Top size (mm)	Power (kW)	Cut out (mm)	Price £
2	<b>SSHRT2</b>	850 x 660 x 540	1.5	725 x 646	<b>£3,395</b>
3	<b>SSHRT3</b>	1177 x 660 x 540	2.4	1045 x 646	<b>£3,695</b>
4	<b>SSHRT4</b>	1504 x 660 x 540	3.0	1370 x 646	<b>£4,075</b>
5	<b>SSHRT5</b>	1831 x 660 x 540	3.9	1700 x 646	<b>£4,330</b>

**For front mounted controls add C to end of Part Number**

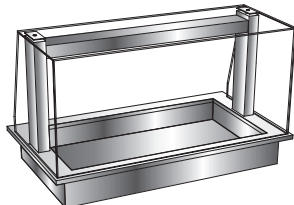
**Heated recessed top - enclosed**

GN1/1 Capacity	Part Number	Top size (mm)	Power (kW)	Cut out (mm)	Price £
2	<b>SFHRT2</b>	850 x 660 x 540	1.5	725 x 646	<b>£3,800</b>
3	<b>SFHRT3</b>	1177 x 660 x 540	2.4	1045 x 646	<b>£4,095</b>
4	<b>SFHRT4</b>	1504 x 660 x 540	3.0	1370 x 646	<b>£4,495</b>
5	<b>SFHRT5</b>	1831 x 660 x 540	3.9	1700 x 646	<b>£4,725</b>

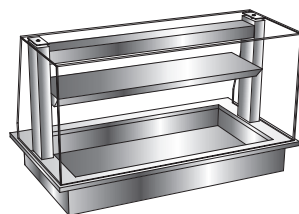
**Heated display deli**

GN1/1 Capacity	Part Number	Top size (mm)	Power (kW)	Cut out (mm)	Price £
2	<b>SFHDL2</b>	850 x 660 x 540	1.4	725 x 646	<b>£5,205</b>
3	<b>SFHDL3</b>	1177 x 660 x 540	2.1	1045 x 646	<b>£5,755</b>
4	<b>SFHDL4</b>	1504 x 660 x 540	2.8	1370 x 646	<b>£5,965</b>

**Extras**

<b>BMCV1</b>	Carvery insert/gravy dish for BM GN1/1 size .....	<b>£300</b>
<b>BMCV2</b>	Carvery insert full size for BM GN1/1 size .....	<b>£250</b>
<b>DHCP1</b>	Ceramic insert GN1/1 size .....	<b>£325</b>
<b>DHTP1</b>	Tiled insert GN1/1 size .....	<b>£355</b>
<b>BMCV3</b>	Carvery insert & Cradle Collar for DHHP units .....	<b>£260</b>

*This collar is not suitable if drop-in is flush fitted in counter top.*

**Topper base**

*Allows heated Synergy drop-in to be used as a table top unit (Ceramic hotplates and 65mm deep baines maries only).*

<b>DHTB1</b>	Topper base heated GN1 size .....	<b>£240</b>
<b>DHTB2</b>	Topper base heated GN2 size .....	<b>£260</b>
<b>DHTB3</b>	Topper base heated GN3 size .....	<b>£295</b>
<b>DHTB4</b>	Topper base heated GN4 size .....	<b>£325</b>

**Refrigerated units - Flat glass**

Designed to meet the EN ISO 23953 standard and provide M1 Cabinet Class conditions exceeding the Climate Class 3 environment of 25°C in 60% RH. In use Victor refrigerated Synergy units will maintain the product core temperature of pre chilled food below 5°C in ambient temperatures up to 27°C - 50% relative humidity. Synergy units are illuminated using LED lamps. All controls are mounted on the unit. Removable fascia grills are provided for mounting on the counter front to allow air intake and to facilitate cleaning. All units have self evaporating condense systems.

**Refrigerated blown air deck**

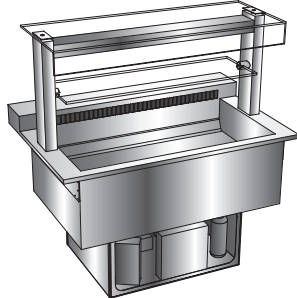

**Refrigerated units can be supplied without compressors for remote refrigeration at a reduction of £515 per unit**

GN1/1 Capacity	Part Number	Top size (mm)	Power (kW)	Cut out (mm)	Price £
2	SSRDK2	850 x 755 x 540	1.6	725 x 646	£5,275
3	SSRDK3	1177 x 755 x 540	1.6	1045 x 646	£5,660
4	SSRDK4	1504 x 755 x 540	2.1	1370 x 646	£5,955
5	SSRDK5	1831 x 755 x 540	2.4	1700 x 646	£6,555

For front mounted controls add C to end of Part Number

**Refrigerated blown air well**

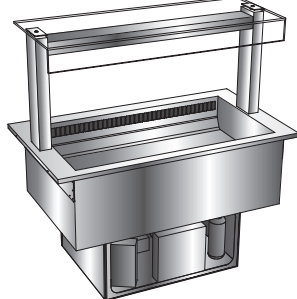

GN1/1 Capacity	Part Number	Top size (mm)	Power (kW)	Cut out (mm)	Price £
2	SSRWL2	850 x 660 x 540	1.6	725 x 646	£5,120
3	SSRWL3	1177 x 660 x 540	1.6	1045 x 646	£5,505
4	SSRWL4	1504 x 660 x 540	2.1	1370 x 646	£5,790
5	SSRWL5	1831 x 660 x 540	2.4	1700 x 646	£6,415

For front mounted controls add C to end of Part Number

**Refrigerated blown air well - enclosed**

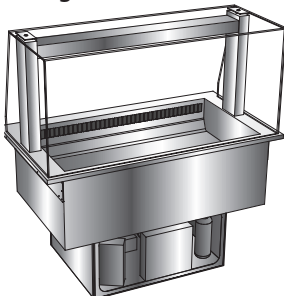

GN1/1 Capacity	Part Number	Top size (mm)	Power (kW)	Cut out (mm)	Price £
2	SFRWL2	850 x 660 x 540	1.6	725 x 646	£5,660
3	SFRWL3	1177 x 660 x 540	1.6	1045 x 646	£6,020
4	SFRWL4	1504 x 660 x 540	2.1	1370 x 646	£6,415
5	SFRWL5	1831 x 660 x 540	2.4	1700 x 646	£7,150

**Refrigerated island well**

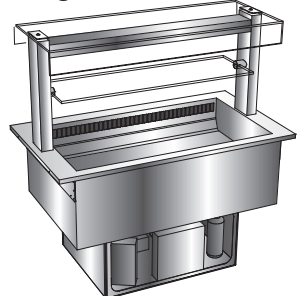

GN1/1 Capacity	Part Number	Top size (mm)	Power (kW)	Cut out (mm)	Price £
2	SSRIW2	850 x 660 x 540	1.6	725 x 646	£5,420
3	SSRIW3	1177 x 660 x 540	1.6	1045 x 646	£5,790
4	SSRIW4	1504 x 660 x 540	2.1	1370 x 646	£6,180
5	SSRIW5	1831 x 660 x 540	2.4	1700 x 646	£7,070

**Refrigerated display deli**

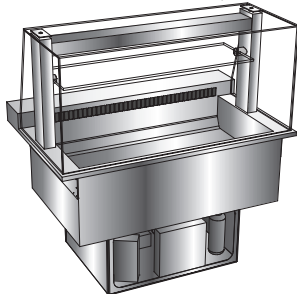

GN1/1 Capacity	Part Number	Top size (mm)	Power (kW)	Cut out (mm)	Price £
2	SFRDL2	850 x 755 x 540	1.6	725 x 646	£5,955
3	SFRDL3	1177 x 755 x 540	1.6	1045 x 646	£6,320
4	SFRDL4	1504 x 755 x 540	2.1	1370 x 646	£6,710
5	SFRDL5	1831 x 755 x 540	2.4	1700 x 646	£7,685

**Extras**

**72-0231** Polyethylene chopping board - 600 x 250 x 40mm **£220**

**Collar for refrigerated well**

**COL016** - GN2/1 size - **£185**      **COL017** - GN3/1 size - **£205**

**Glass mid shelf**

GN2/1 size - **£260**    GN3/1 size - **£260**    GN4/1 size - **£300**    GN5/1 size - **£340**

For full product specification see Victor product brochure or visit [www.victoronline.co.uk](http://www.victoronline.co.uk)

email: [sales@victormfg.co.uk](mailto:sales@victormfg.co.uk)

tel: 01274 722125

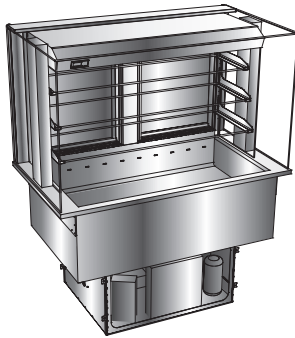
**Refrigerated three tier multi-deck**

**- doors to rear**

GN1/1 Capacity	Part Number	Top size (mm)	Power (kW)	Cut out (mm)	Price £
2	SSRMT2	850 x 660 x 710	2.1	725 x 646	£7,830
3	SSRMT3	1177 x 660 x 710	2.6	1045 x 646	£8,280
4	SSRMT4	1504 x 660 x 710	3.0	1370 x 646	£9,340
5	SSRMT5	1831 x 660 x 710	3.4	1700 x 646	£10,395

**- solid back wall version**

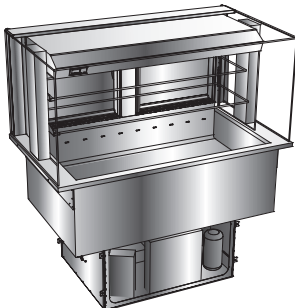
GN1/1 Capacity	Part Number	Top size (mm)	Power (kW)	Cut out (mm)	Price £
2	SSRMT2W	850 x 660 x 710	2.1	725 x 646	£7,375
3	SSRMT3W	1177 x 660 x 710	2.6	1045 x 646	£7,830
4	SSRMT4W	1504 x 660 x 710	3.0	1370 x 646	£8,885
5	SSRMT5W	1831 x 660 x 710	3.4	1700 x 646	£9,935

**Refrigerated two tier multi-deck**

**- doors to rear**

GN1/1 Capacity	Part Number	Top size (mm)	Power (kW)	Cut out (mm)	Price £
2	SSRMT22	850 x 660 x 540	2.1	725 x 646	£7,535
3	SSRMT23	1177 x 660 x 540	2.6	1045 x 646	£7,985
4	SSRMT24	1504 x 660 x 540	3.0	1370 x 646	£9,035
5	SSRMT25	1831 x 660 x 540	3.4	1700 x 646	£10,085

**- solid back wall version**

GN1/1 Capacity	Part Number	Top size (mm)	Power (kW)	Cut out (mm)	Price £
2	SSRMT22W	850 x 660 x 540	2.1	725 x 646	£7,070
3	SSRMT23W	1177 x 660 x 540	2.6	1045 x 646	£7,535
4	SSRMT24W	1504 x 660 x 540	3.0	1370 x 646	£8,580
5	SSRMT25W	1831 x 660 x 540	3.4	1700 x 646	£9,645

Victor Synergy units are supplied with an integral telescopic baffling and air duct system arrangement to facilitate various venting configurations. The majority can be achieved without pre-specifying, but if it is envisaged that a refrigerated unit will be installed without access to the front of the refrigeration housing, (e.g. behind a dwarf wall), please contact our sales department to ensure that the correct unit is supplied.

**Heated units without gantries**

Ceramic and Bain Marie units can be supplied without the superstructure. These come complete with 1.5 metres of cable and an energy regulator (supplied loose) for mounting into a suitable control panel.

An alternative Synergy control box can be supplied as an optional extra.

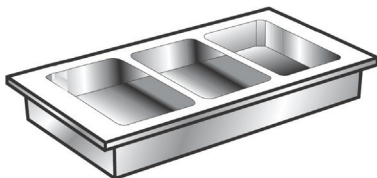
**Heated Bains Marie - Dry heat 65mm deep well**

GN1/1 Capacity	Part Number	Top size (mm)	Power (kW)	Cut out (mm)	Price £
2	WDHBM2	850 x 660 x 20	0.9	725 x 636	£1,080
3	WDHBM3	1177 x 660 x 20	1.5	1045 x 636	£1,135
4	WDHBM4	1504 x 660 x 20	1.8	1370 x 636	£1,230
5	WDHBM5	1831 x 660 x 20	2.4	1700 x 636	£1,300
6	WDHBM6	2158 x 660 x 20	3.0	2025 x 636	£1,450

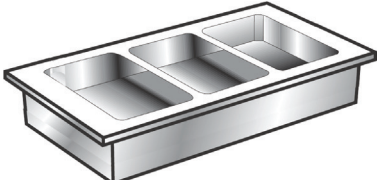
**Heated Bains Marie - Dry heat 150mm deep well**

GN1/1 Capacity	Part Number	Top size (mm)	Power (kW)	Cut out (mm)	Price £
2	WDHBD2	850 x 660 x 20	0.9	725 x 636	£1,080
3	WDHBD3	1177 x 660 x 20	1.5	1045 x 636	£1,135
4	WDHBD4	1504 x 660 x 20	1.8	1370 x 636	£1,230
5	WDHBD5	1831 x 660 x 20	2.4	1700 x 636	£1,300
6	WDHBD6	2158 x 660 x 20	3.0	2025 x 636	£1,450

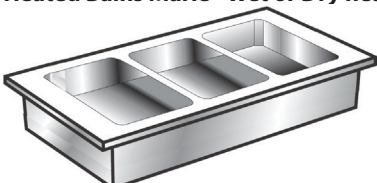
**Heated Bains Marie - Wet or Dry heat 150mm deep well**

GN1/1 Capacity	Part Number	Top size (mm)	Power (kW)	Cut out (mm)	Price £
2	WDHBW2	850 x 660 x 20	0.9	725 x 646	£1,240
3	WDHBW3	1177 x 660 x 20	1.5	1045 x 646	£1,360
4	WDHBW4	1504 x 660 x 20	1.8	1370 x 646	£1,455
5	WDHBW5	1831 x 660 x 20	2.4	1700 x 646	£1,655

**Heated ceramic hot plate**

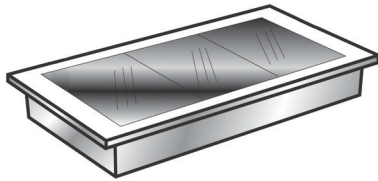

GN1/1 Capacity	Part Number	Top size (mm)	Power (kW)	Cut out (mm)	Price £
2	<b>WDHHP2</b>	850 x 660 x 20	0.9	725 x 636	<b>£1,340</b>
3	<b>WDHHP3</b>	1177 x 660 x 20	1.5	1045 x 636	<b>£1,455</b>
4	<b>WDHHP4</b>	1504 x 660 x 20	1.8	1370 x 636	<b>£1,500</b>
5	<b>WDHHP5</b>	1831 x 660 x 20	2.4	1700 x 636	<b>£1,645</b>
6	<b>WDHHP6</b>	2158 x 660 x 20	3.0	2025 x 636	<b>£1,735</b>

**Optional Extra**

Heated units without gantries are supplied with an energy regulator and cable which needs to be suitably mounted. An optional control box to ease the installation process can be ordered.

**SYBOX** Synergy control box .....**£610**

**Refrigerated blown air well without gantry**

Refrigerated wells can be supplied without the superstructure. These come complete with control box to be mounted within 2 metres of the unit.

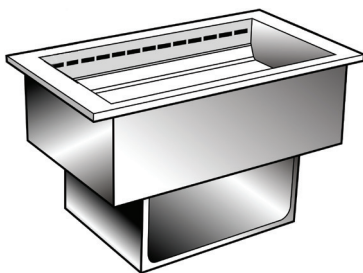

GN1/1 Capacity	Part Number	Top size (mm)	Power (kW)	Cut out (mm)	Price £
2	<b>WDRWL2</b>	850 x 660 x 20	1.6	725 x 646	<b>£4,820</b>
3	<b>WDRWL3</b>	1177 x 660 x 20	1.6	1045 x 646	<b>£5,050</b>
4	<b>WDRWL4</b>	1504 x 660 x 20	2.1	1370 x 646	<b>£5,420</b>
5	<b>WDRWL5</b>	1831 x 660 x 20	2.4	1700 x 646	<b>£5,790</b>

**Refrigerated frost top units**

Frost top units designed to be installed under or dropped into a suitable counter top. Thermal break must be provided around the top dimension for effective operation, supplied with control box.

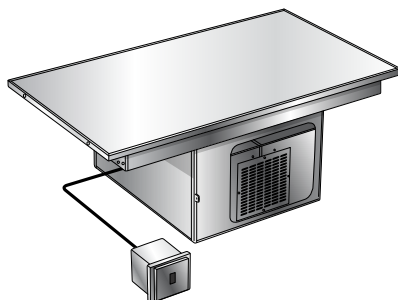

**Through vent models,**

GN1/1 Capacity	Part Number	Top size (mm)	Power (kW)	Cut out (mm)	Price £
2	<b>WDRCC2</b>	850 x 660	0.5	725 x 646	<b>£4,065</b>
3	<b>WDRCC3</b>	1177 x 660	0.5	1045 x 646	<b>£4,290</b>
4	<b>WDRCC4</b>	1504 x 660	0.7	1370 x 646	<b>£4,595</b>
5	<b>WDRCC5</b>	1831 x 660	0.7	1700 x 646	<b>£4,820</b>

**For side vent models add D to end of Part Number**

<b>Extras</b>		<b>Price £</b>
<b>61-0091</b>	Heat transfer compound 300ml cartridge tube	<b>£30</b>

**Essential when installing under a suitable top (Refer to table below for quantity needed)**

Pan quantity	Tubes required
2	1
3	2
4	2
5	2

**For full product specification see Victor product brochure or visit [www.victoronline.co.uk](http://www.victoronline.co.uk)**

email: [sales@victormfg.co.uk](mailto:sales@victormfg.co.uk)

tel: 01274 722125

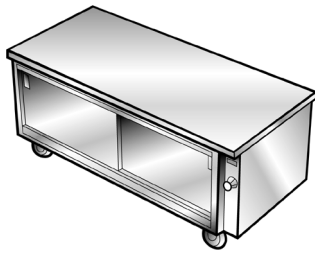
**Roll under hot cupboards**

Roll under low height (700mm) stainless steel fan assisted hot cupboards. Units feature heavy duty castors, digital temperature display, top hung sliding doors, 1 removable shelf, coolwall exterior & adjustable thermostat control. Supplied with a 13 amp plug.

Part Number	Dimensions (mm)	Power (kW)	Price £
<b>ROLLHOT10</b>	1000 x 700 x 700	1.0	<b>£2,735</b>
<b>ROLLHOT12</b>	1175 x 700 x 700	1.0	<b>£2,735</b>
<b>ROLLHOT15</b>	1525 x 700 x 700	2.0	<b>£3,090</b>
<b>ROLLHOT18</b>	1825 x 700 x 700	2.0	<b>£3,370</b>

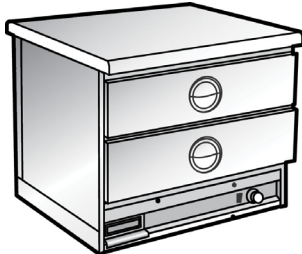
**Heated drawer unit**

A slide under heated drawer unit designed to be positioned under a counter. Accepts 4 x GN1/1 containers (not included), two per drawer. Mounted on small rollers to the rear and levelling feet to the front.

Part Number	Dimensions (mm)	Power (kW)	Price £
<b>HD75RU2</b>	760 x 650 x 655	1.0	<b>£4,015</b>

**Soup well**

Approx. 10 litre capacity round pot with hinged lid. Three temperature set points from 50° to 100°C for warming, steaming and boiling. Dry heat unit, no drain-off point or water required, stainless steel construction, complete with remote control panel and 13 amp plug.

Part Number	Dimensions (mm)	Power (kW)	Price £
10 litre capacity <b>DHSS2</b>	312mm dia	1.37	<b>£755</b>
<b>Extras</b>			
<b>72-0491</b>	Additional hinged lid.....		<b>£80</b>
<b>72-0492</b>	Additional spare pot.....		<b>£155</b>

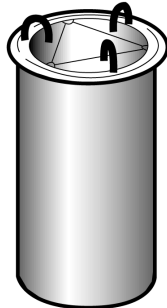
**Adjustable plate dispensers**

Drop in heated and unheated plate dispenser. Three adjustable guide rods mounted through a circular flange. Capacity is approximately 55-65 plates. Flange finished in 304 grade stainless steel. Heated units are fitted with a rocker switch and controlled by a fixed 70°C thermostat.

	Part Number	Plate dia (mm)	Flange dia (mm)	Power (kW)	Cut out dia (mm)	Price £
Ambient	<b>72-0315</b>	<b>185-255</b>	<b>359</b>	-	342	<b>£850</b>
Ambient	<b>70-0190</b>	<b>210-285</b>	<b>382</b>	-	370	<b>£1,240</b>
Heated	<b>72-0320</b>	<b>185-255</b>	<b>359</b>	0.4	342	<b>£1,790</b>
Heated	<b>72-0325</b>	<b>210-285</b>	<b>382</b>	0.4	370	<b>£1,790</b>
<b>Extras</b>	<b>70-0210</b>		Lid for heated models.....			<b>£95</b>

**Ambient cutlery & condiment unit**

Complementary condiment & cutlery units are available in two sizes. Accepts 2/3GN containers (not included) to inclined top shelf and circular cutlery containers (not included) to inclined lower base.

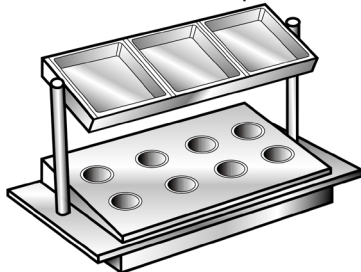

	Part Number	Top size (mm)	Power (kW)	Price £
Cutlery unit	<b>DRAC2</b>	900 x 660 x 540	-	<b>£1,650</b>
	<b>DRAC3</b>	1252 x 660 x 540	-	<b>£1,715</b>
<b>Extras</b>	<b>GN2/3-65</b>	GN2/3 x 65mm container .....		<b>£35</b>
	<b>DACC1</b>	St.St perforated cutlery cylinder .....		<b>£15</b>

**Ambient shelf display unit**

Complementary display unit comprising of curved glass screen and two fixed 10mm thick glass ambient shelves or wire baskets are suspended from the gantry arms.

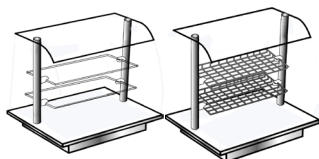

	Part Number	Top size (mm)	Power (kW)	Price £
Glass shelf unit	<b>DRAG2</b>	850 x 660 x 710	-	<b>£2,075</b>
Wire shelf unit	<b>DRAW2</b>	850 x 660 x 710	-	<b>£2,075</b>

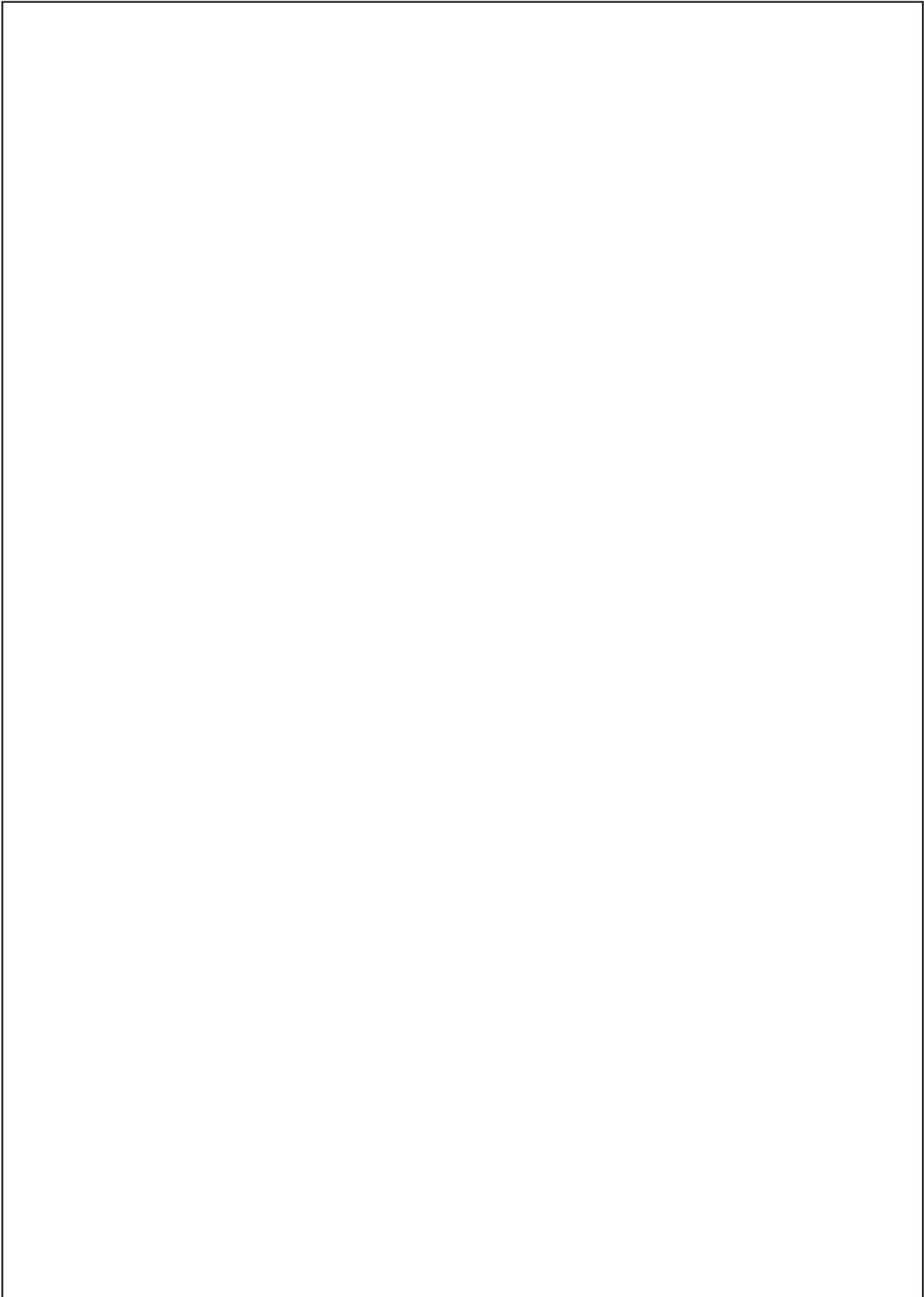

***For full product specification see Victor product brochure or visit [www.victoronline.co.uk](http://www.victoronline.co.uk)***

email: [sales@victormfg.co.uk](mailto:sales@victormfg.co.uk)

tel: 01274 722125

**Victor Manufacturing Ltd**

Prospect Works, South Street  
Keighley  
West Yorkshire  
BD21 5AA

Phone  
**01274 722125**

Email  
**sales@victormfg.co.uk**

Website  
**www.victoronline.co.uk**

VWL PL 03/26

